

ROTARY MOTORS S SERIES

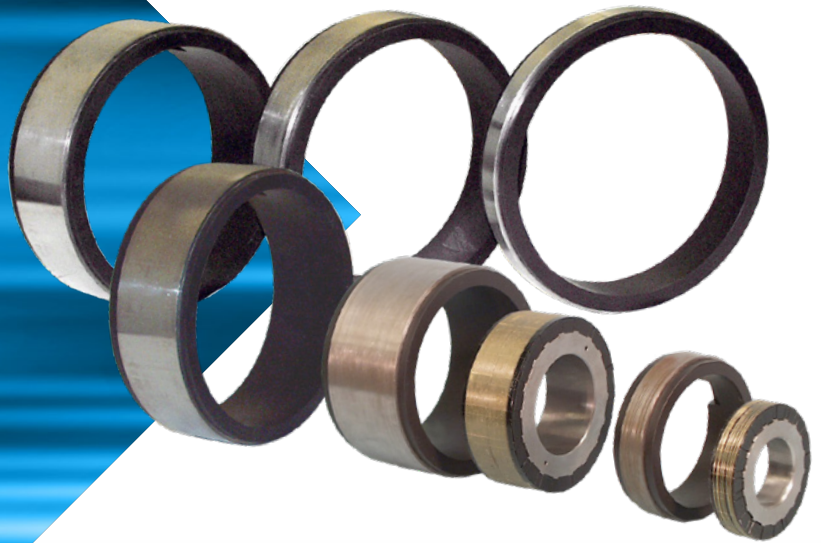

The S-series motors are Aerotech's high-performance brushless, frameless torque motors. The motors feature neodymium iron boron magnets for maximum torque and acceleration in a compact assembly.

High-Performance Design

The S-series motors utilize a slotless stator design and high pole-count rotor to provide zero cogging for exceptional velocity stability. The laminations contain no slots, eliminating torque ripple and cogging torque that produces velocity disturbance. The S-series motors are well-suited for direct-drive applications such as printing and scanning where velocity ripple cannot be tolerated.

Wide Range of Output Torque and Sizes

The S-series slotless motors cover a wide range of torque and package sizes. Continuous torque ranges from 0.20 N-m to 29.09 N-m. Peak torque ranges from 0.82 N-m to 116.37 N-m. The open design of the S-series motors allows for custom winding or mechanical variations to meet any application need.

The S-series motors are designed for applications in OEM machines. The S-50 (50-mm diameter) motor is ideal for small, tight spaces such as spindles or small feed rolls. The S-180 (180 mm diameter) and S-240 (240 mm diameter) can accelerate large print drums or precision positioning tables.

Easy Machine Integration

All S-series motors are supplied as two pieces – a slotless stator coil and permanent magnet rotor. The stator is a standard 3-phase coil assembly with Hall-effect devices. They can be driven using a simple six-step or sinusoidal commutation algorithm. Aerotech's Ndrive series amplifiers are performance-matched to the S-series motors for easy integration. The hollow rotor mounts directly to a drive axis with no gearing required.

Custom variations can be engineered to your requirements with minimal lead time.



S-series motor is used in Aerotech's high-performance ADR direct-drive rotary stage.

PRODUCT HIGHLIGHTS

Slotless, brushless ring motors with high torque output and zero cogging

Frameless design for easy integration into OEM machines

Various winding options available

Includes Hall effect sensors for commutation

Follows the 2011/65/EU RoHS 2 Directive

S Series Specifications

Model	Units	S-50-39		S-50-52		S-50-86		S-76-35		S-76-85		S-76-149	
Winding Designation		-A	-B	-A	-B	-A	-B	-A	-B	-A	-B	-A	-B
Performance Specifications^{1,2}													
Stall Torque, Continuous ³	N·m	0.20		0.33		0.56		0.48		1.60		2.86	
Peak Torque ⁴	N·m	0.82		1.31		2.26		1.92		6.41		11.43	
Rated Speed	rpm	4000	8000	4000	8000	3000	8000	3000	5000	3000	4000	2000	1500
Rated Power Output, Continuous	W	82.1	157.1	117.7	198.0	131.9	149.5	143.3	203.5	381.6	453.2	459.1	369.9
Electrical Specifications²													
BEMF Constant (Line-Line, Max)	$V_{pk}/krpm$	10.3	3.4	19.0	6.3	40	13.3	29.1	14.5	57	38	79	118.5
Continuous Current, Stall ³	A_{pk}	2.40	7.2	2.3	6.9	2.1	6.3	2.0	4.0	3.8	5.7	4.9	3.27
	A_{rms}	1.7	5.1	1.6	4.9	1.5	4.5	1.4	2.8	2.7	4.0	3.5	2.3
Peak Current, Stall ⁴	A_{pk}	9.6	28.8	9.2	27.6	8.4	25.2	8.0	16.0	15.2	22.8	19.6	13.1
Torque Constant ^{5,6}	$N·m/A_{pk}$	0.09	0.03	0.14	0.05	0.27	0.09	0.24	0.12	0.42	0.28	0.58	0.87
	$N·m/A_{rms}$	0.12	0.04	0.20	0.07	0.38	0.13	0.34	0.17	0.60	0.40	0.82	1.24
Motor Constant ^{3,5}	$N·m/\sqrt{W}$	0.034		0.050		0.076		0.075		0.179		0.280	
Resistance, 25°C, (Line-Line)	Ω	6.6	0.7	8.4	0.9	12.9	1.4	10.5	2.6	5.7	2.5	4.4	10.0
Inductance (Line-Line)	mH	1.50	0.17	1.30	0.14	2.40	0.27	1.40	0.35	1.10	0.49	0.87	1.96
Maximum Bus Voltage	VDC	340											
Thermal Resistance	°C/W	2.02		1.73		1.35		1.83		0.93		0.72	
Number of Poles	P	8						14					
Mechanical Specifications													
Frameless Motor Weight	kg	0.32		0.48		0.90		0.64		2.20		4.30	
Frameless Rotor Inertia	$kg·m^2$	1.11×10^{-5}		1.70×10^{-5}		3.40×10^{-5}		1.06×10^{-4}		4.20×10^{-4}		8.30×10^{-4}	
Length of Winding, Frameless Motor	mm	39.1		51.8		85.8		35.0		84.8		149.0	
Outside Diameter, Frameless Motor	mm	50.8						76.0					
Max. Axial Load	N	9.5						30.0					
Standards		2011/65/EU RoHS 2 Directive											

1 Performance is dependent upon heat sink configuration, system cooling conditions, and ambient temperature.

2 All performance and electrical specifications $\pm 10\%$.

3 Values shown @ 75°C rise above a 25°C ambient temperature, with housed motor mounted to a 250 mm x 250 mm x 6 mm aluminum heat sink.

4 Peak torque assumes correct rms current; consult Aerotech.

5 Torque constant and motor constant specified at stall.

6 All Aerotech amplifiers are rated A_{pk} ; use torque constant in $N·m/A_{pk}$ when sizing.

S Series Specifications

Model	Units	S-130-39		S-130-60		S-130-102	
Winding Designation		-A	-B	-A	-B	-A	-B
Performance Specifications^{1,2}							
Stall Torque, Continuous ³	N·m	2.36		4.18		7.69	
Peak Torque ⁴	N·m	9.42		16.73		30.75	
Rated Speed	rpm	2000	4000	1000	2000	500	1000
Rated Power Output, Continuous	W	493.4	986.9	437.9	875.9	402.5	805.1
Electrical Specifications²							
BEMF Constant (Line-Line, Max)	$V_{pk}/krpm$	75.1	37.5	148.9	74.4	300.2	150.1
Continuous Current, Stall ³	A_{pk}	3.8	7.6	3.4	6.8	3.1	6.2
	A_{rms}	2.7	5.4	2.4	4.8	2.2	4.4
Peak Current, Stall ⁴	A_{pk}	15.2	30.4	13.6	27.2	12.4	24.8
Torque Constant ^{5,6}	$N·m/A_{pk}$	0.62	0.31	1.23	0.62	2.48	1.24
	$N·m/A_{rms}$	0.88	0.44	1.74	0.87	3.51	1.75
Motor Constant ^{3,5}	$N·m/\sqrt{W}$	0.265		0.446		0.710	
Resistance, 25°C, (Line-Line)	Ω	5.6	1.4	7.8	2.0	12.5	3.1
Inductance (Line-Line)	mH	1.70	0.43	1.80	0.45	3.67	0.92
Maximum Bus Voltage	VDC	340					
Thermal Resistance	°C/W	0.95		0.85		0.64	
Number of Poles	P	18					
Mechanical Specifications							
Frameless Motor Weight	kg	1.87		3.60		7.00	
Frameless Rotor Inertia	$kg·m^2$	1.60×10^{-3}		3.00×10^{-3}		6.20×10^{-3}	
Length of Winding, Frameless Motor	mm	38.7		59.7		101.7	
Outside Diameter, Frameless Motor	mm	128.9					
Max. Axial Load	N	50.8					
Standards		2011/65/EU RoHS 2 Directive					

1 Performance is dependent upon heat sink configuration, system cooling conditions, and ambient temperature.

2 All performance and electrical specifications $\pm 10\%$.

3 Values shown @ 75°C rise above a 25°C ambient temperature, with housed motor mounted to a 330 mm x 300 mm x 13 mm aluminum heat sink.

4 Peak torque assumes correct rms current; consult Aerotech.

5 Torque constant and motor constant specified at stall.

6 All Aerotech amplifiers are rated A_{pk} ; use torque constant in $N·m/A_{pk}$ when sizing.

S Series Specifications

Model	Units	S-180-44		S-180-69		S-180-94		S-240-43		S-240-63		S-240-83	
Winding Designation		-A	-B	-A	-B	-A	-B	-A	-B	-A	-B	-A	-B
Performance Specifications^{1,2}													
Stall Torque, Continuous ³	N·m	5.99		11.12		15.93		10.73		19.71		29.09	
Peak Torque ⁴	N·m	23.98		44.47		63.70		42.90		78.82		116.37	
Rated Speed	rpm	500	1,000	500	1,000	250	500	600	1,200	250	500	200	400
Rated Power Output, Continuous	W	302.2	581.2	570.5	1117.7	408.6	799.6	663.2	1303.4	507.1	996.7	599.0	1117.2
Electrical Specifications²													
BEMF Constant (Line-Line, Max)	V _{pk} /krpm	268.7	134.4	263.9	131.9	393.4	196.7	209.4	104.7	404.3	202.2	607.2	303.6
Continuous Current, Stall ³	A _{pk}	2.7	5.4	5.1	10.2	4.9	9.8	6.2	12.4	5.9	11.8	5.8	11.6
	A _{rms}	1.9	3.8	3.6	7.2	3.5	6.9	4.4	8.8	4.2	8.3	4.1	8.2
Peak Current, Stall ⁴	A _{pk}	10.8	21.6	20.4	40.8	19.6	39.2	24.8	49.6	23.6	47.2	23.2	46.4
Torque Constant ^{5,6}	N·m/A _{pk}	2.22	1.11	2.18	1.09	3.25	1.63	1.73	0.87	3.34	1.67	5.02	2.51
	N·m/A _{rms}	3.14	1.57	3.08	1.54	4.60	2.30	2.45	1.22	4.72	2.36	7.09	3.55
Motor Constant ^{3,5}	N·m/W	0.628		1.053		1.391		0.845		1.405		1.893	
Resistance, 25°C, (Line-Line)	Ω	12.8	3.2	4.4	1.1	5.6	1.4	4.3	1.1	5.8	1.5	7.2	1.8
Inductance (Line-Line)	mH	3.40	0.85	1.70	0.43	2.60	0.65	2.15	0.54	2.90	0.73	4.30	1.08
Maximum Bus Voltage	VDC	340											
Thermal Resistance	°C/W	0.82		0.67		0.57		0.47		0.38		0.32	
Number of Poles	P	18						26					
Mechanical Specifications													
Frameless Motor Weight	kg	4.24		8.10		11.90		5.80		11.00		16.20	
Frameless Rotor Inertia	kg·m ²	7.40x10 ⁻³		1.48x10 ⁻²		2.20x10 ⁻²		2.30x10 ⁻²		4.50x10 ⁻²		7.00x10 ⁻²	
Length of Winding, Frameless Motor	mm	43.2		68.2		93.2		42.7		62.7		82.7	
Outside Diameter, Frameless Motor	mm	180.0						239.2					
Max. Axial Load	N	86.4						120.6					
Standards		2011/65/EU RoHS 2 Directive											

1 Performance is dependent upon heat sink configuration, system cooling conditions, and ambient temperature.

2 All performance and electrical specifications ±10%.

3 Values shown @ 75°C rise above a 25°C ambient temperature, with housed motor mounted to a 330 mm x 300 mm x 13 mm aluminum heat sink.

4 Peak torque assumes correct rms current; consult Aerotech.

5 Torque constant and motor constant specified at stall.

6 All Aerotech amplifiers are rated A_{pk}; use torque constant in N·m/A_{pk} when sizing.

S Series Motor Performance

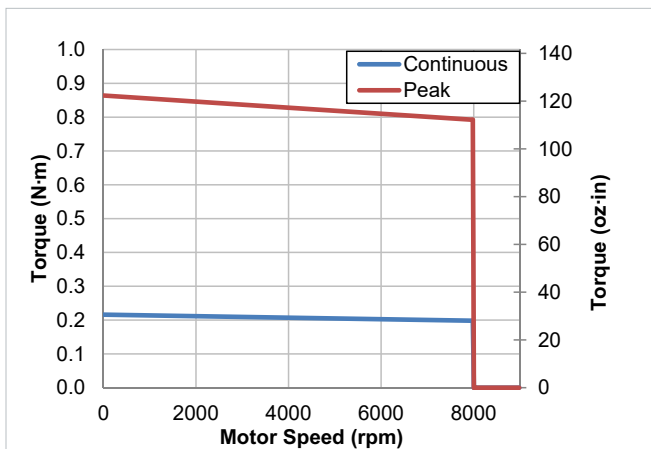

S-50-39-A Torque vs Speed

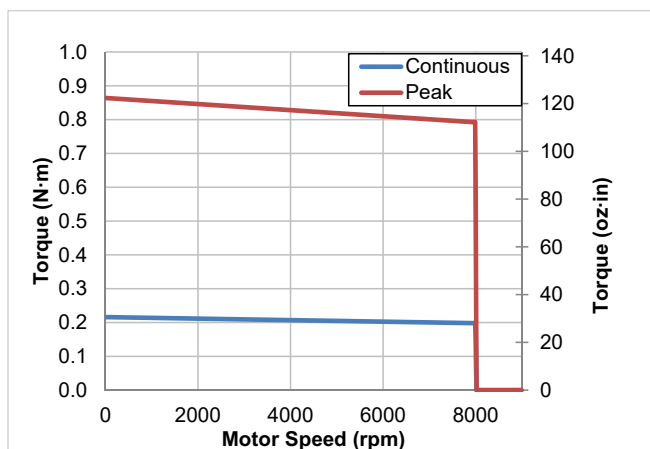

S-50-39-B Torque vs Speed

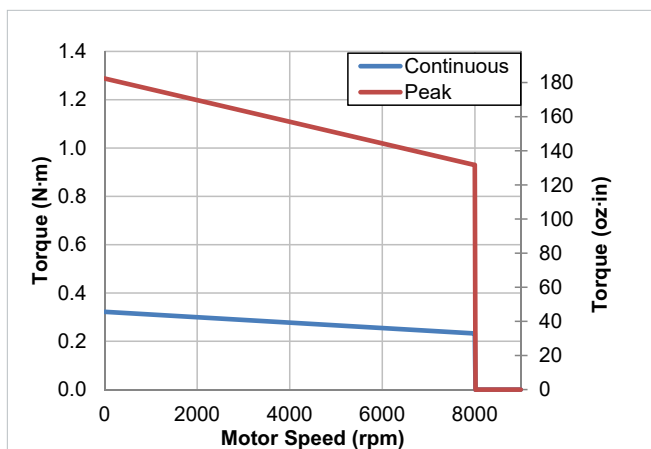

S-50-52-A Torque vs Speed

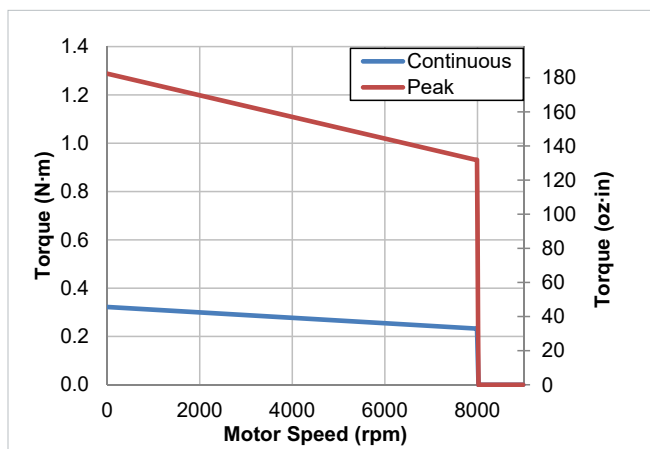

S-50-52-B Torque vs Speed

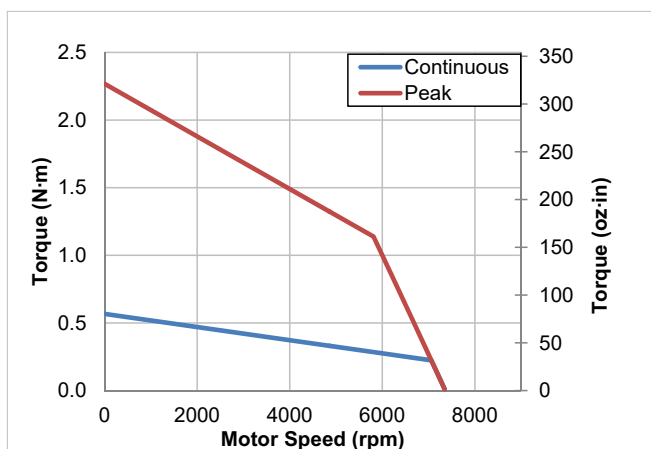

S-50-86-A Torque vs Speed

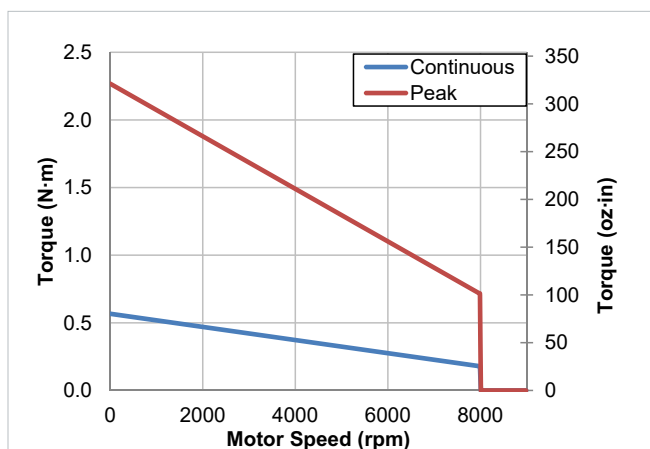

S-50-86-B Torque vs Speed

S Series Motor Performance

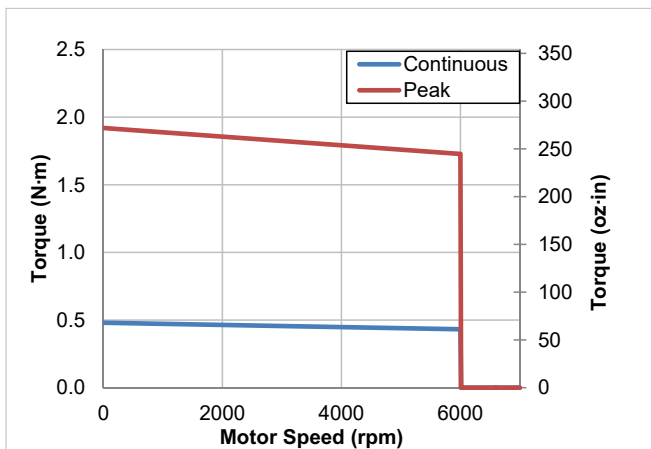

S-76-35-A Torque vs Speed

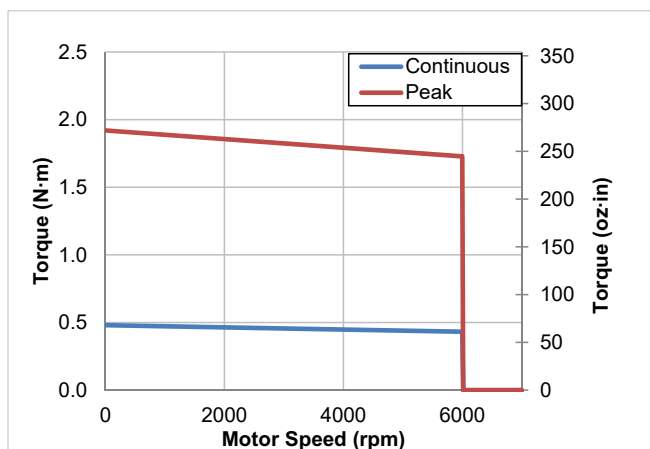

S-76-35-B Torque vs Speed

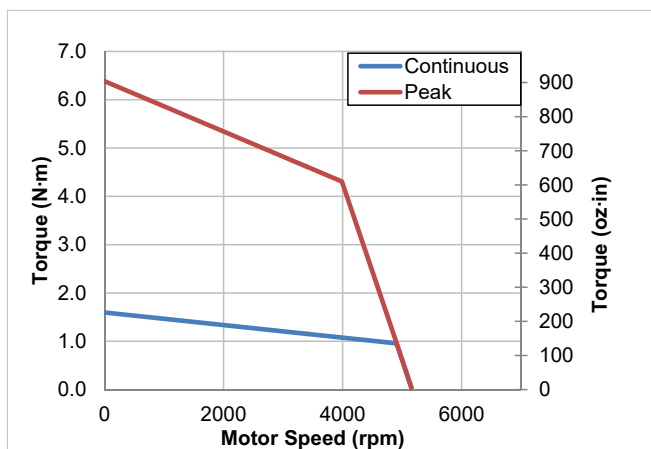

S-76-85-A Torque vs Speed

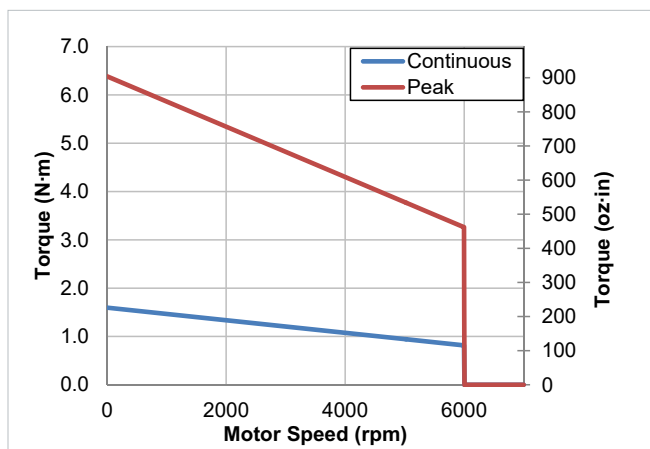

S-76-85-B Torque vs Speed

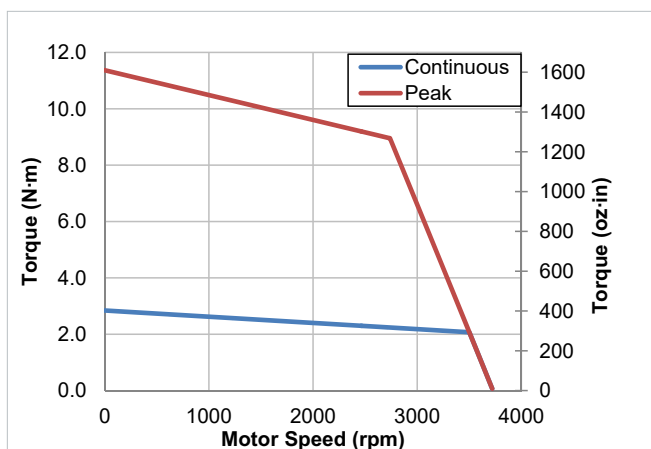

S-76-149-A Torque vs Speed

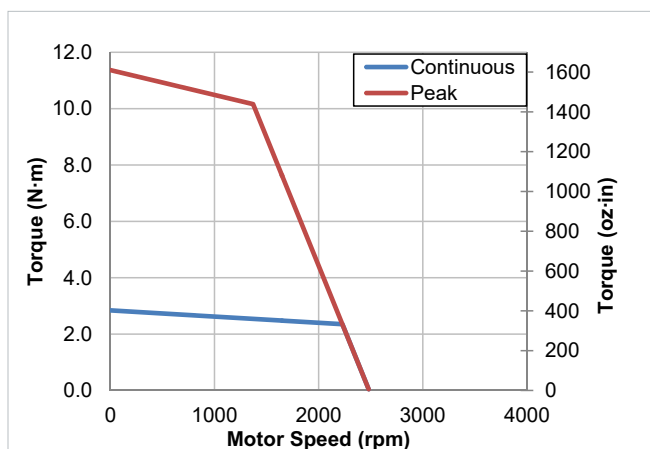

S-76-149-B Torque vs Speed

S Series Motor Performance

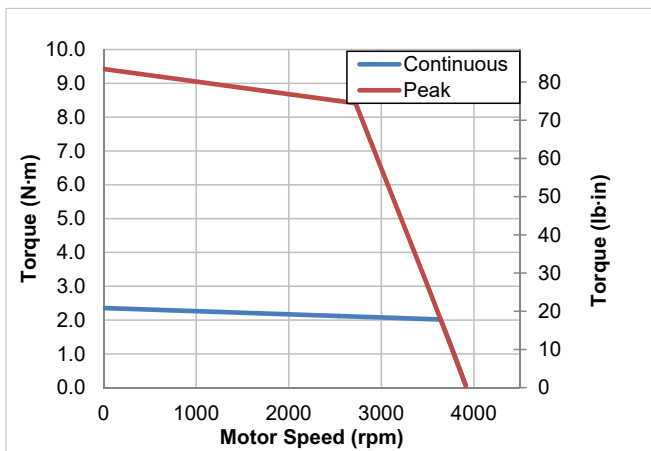

S-130-39-A Torque vs Speed

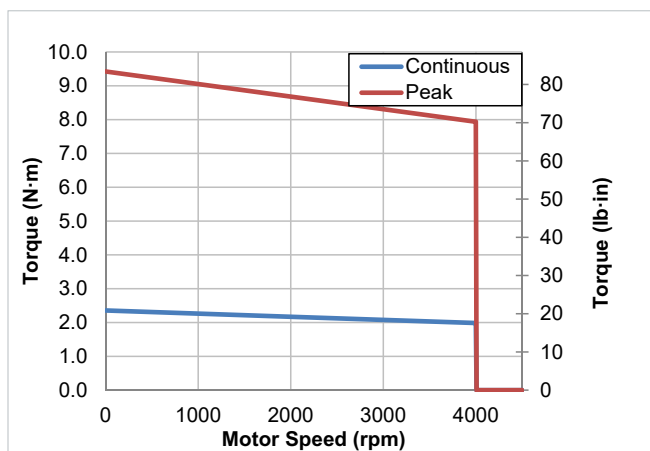

S-130-39-B Torque vs Speed

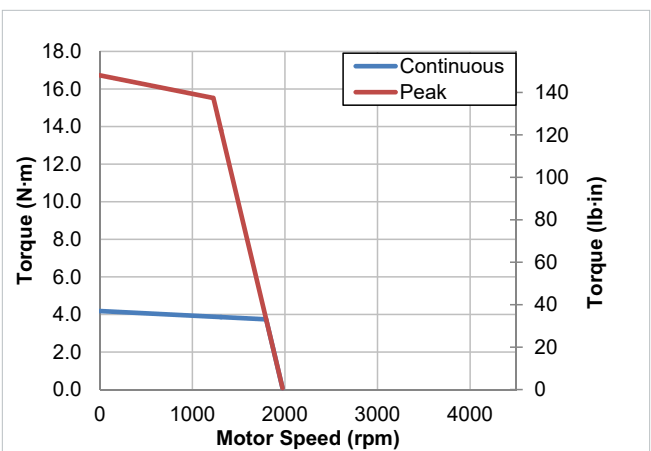

S-130-60-A Torque vs Speed

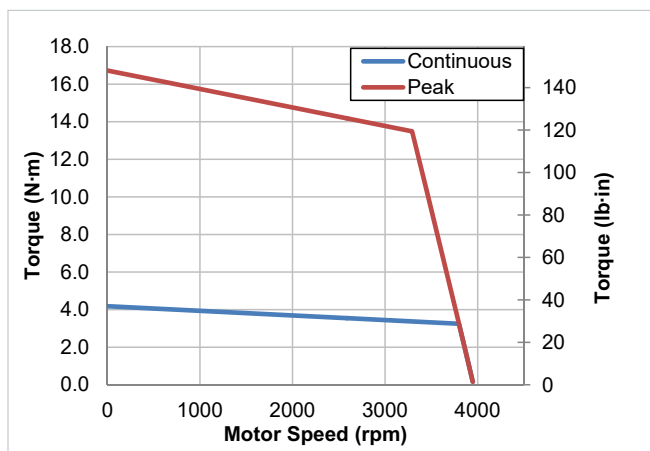

S-130-60-B Torque vs Speed

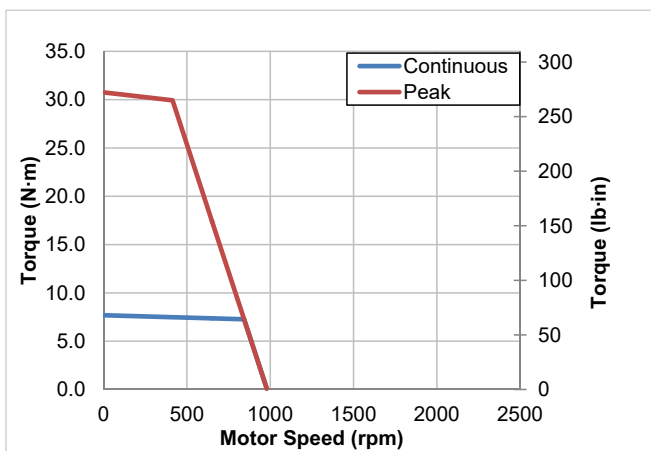

S-130-102-A Torque vs Speed

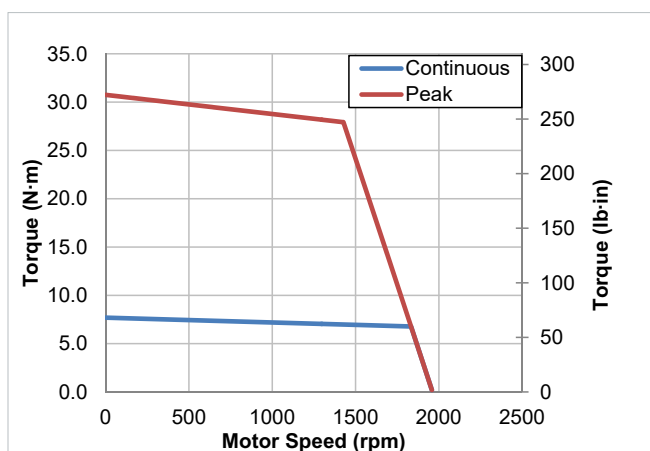

S-130-102-B Torque vs Speed

S Series Motor Performance

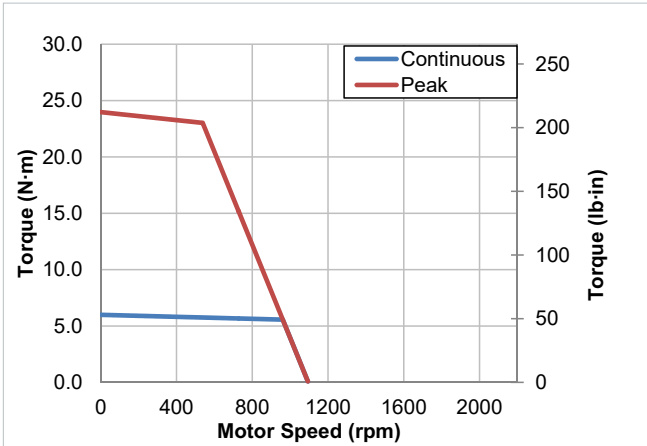

S-180-44-A Torque vs Speed

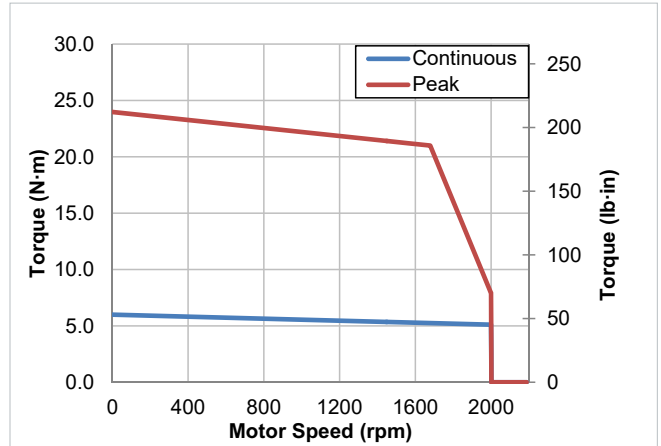

S-180-44-B Torque vs Speed

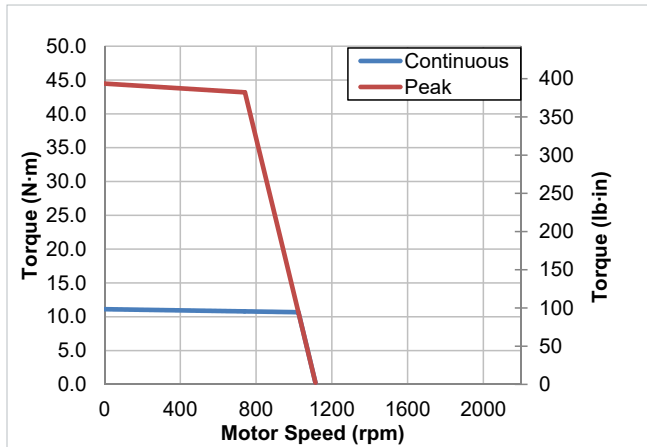

S-180-69-A Torque vs Speed

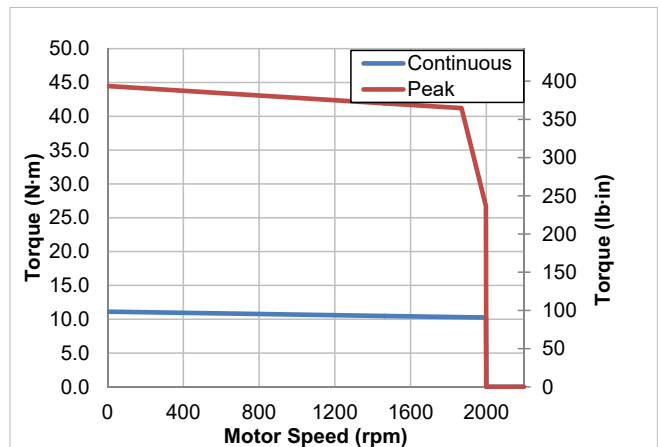

S-180-69-B Torque vs Speed

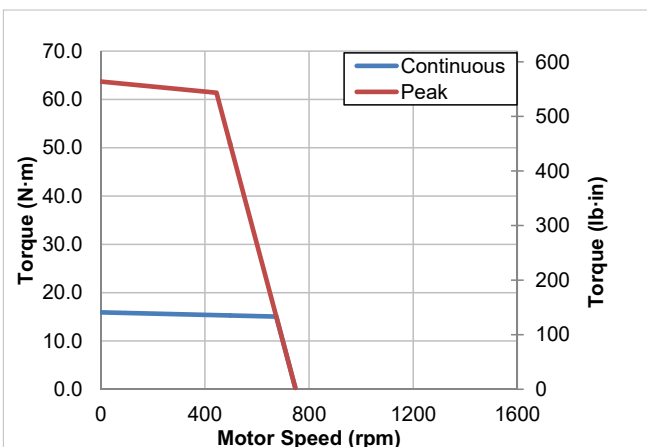

S-180-94-A Torque vs Speed

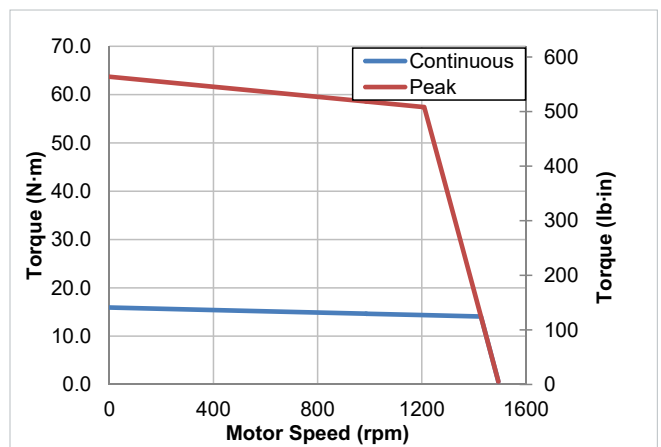

S-180-94-B Torque vs Speed

S Series Motor Performance

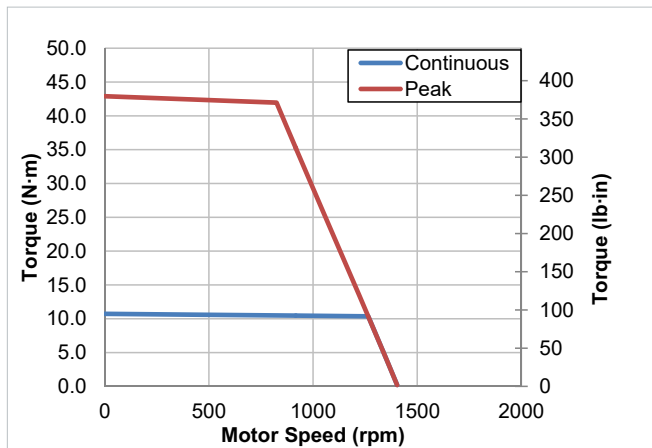

S-240-43-A Torque vs Speed

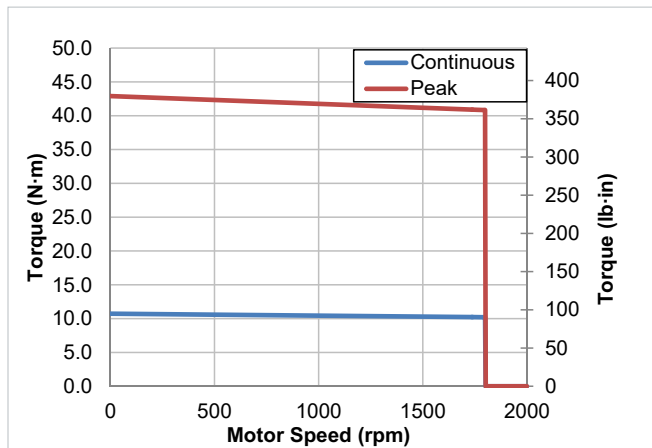

S-240-43-B Torque vs Speed

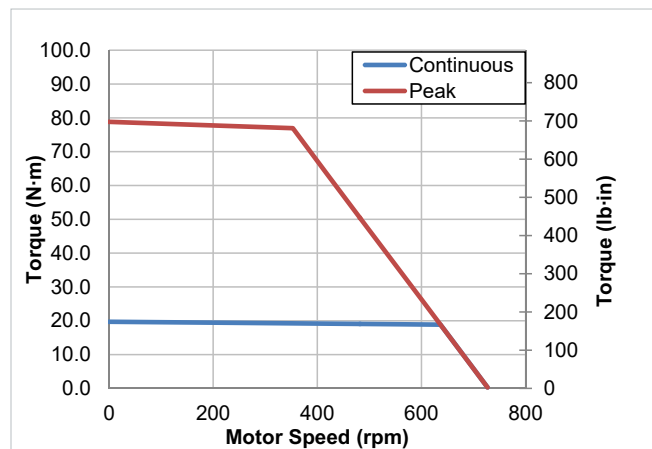

S-240-63-A Torque vs Speed

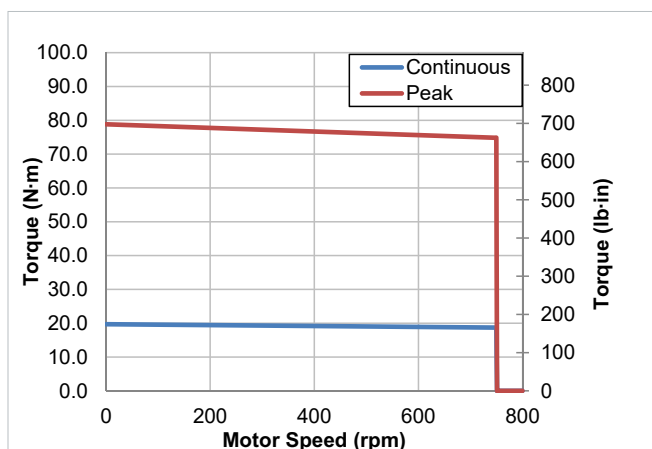

S-240-63-B Torque vs Speed

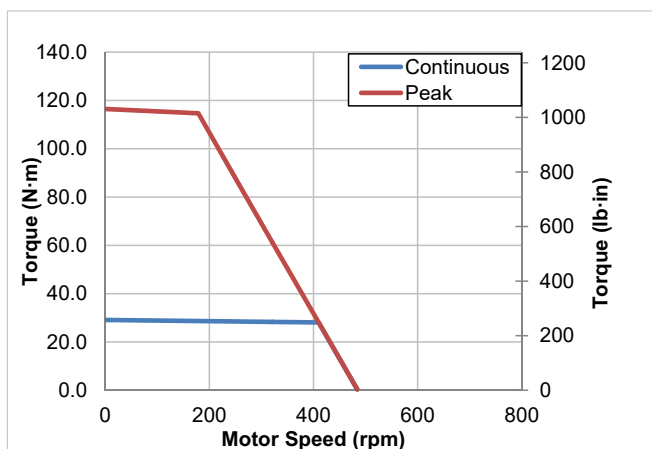

S-240-83-A Torque vs Speed

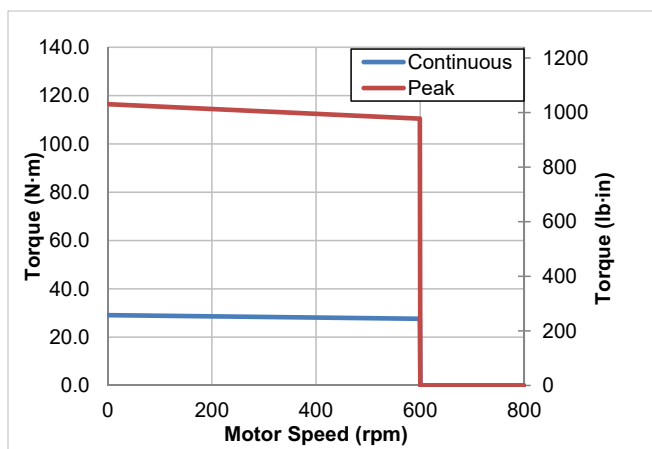

S-240-83-B Torque vs Speed

S Series Dimensions

S-50

Dimensions - millimeters [inches]

Model No.	A	B	C
S-50-39	21.3 [0.84]	22.0 [0.87]	39.1 [1.54]
S-50-52	34.0 [1.34]	34.8 [1.37]	51.8 [2.04]
S-50-86	67.0 [2.64]	68.8 [2.71]	84.8 [3.34]

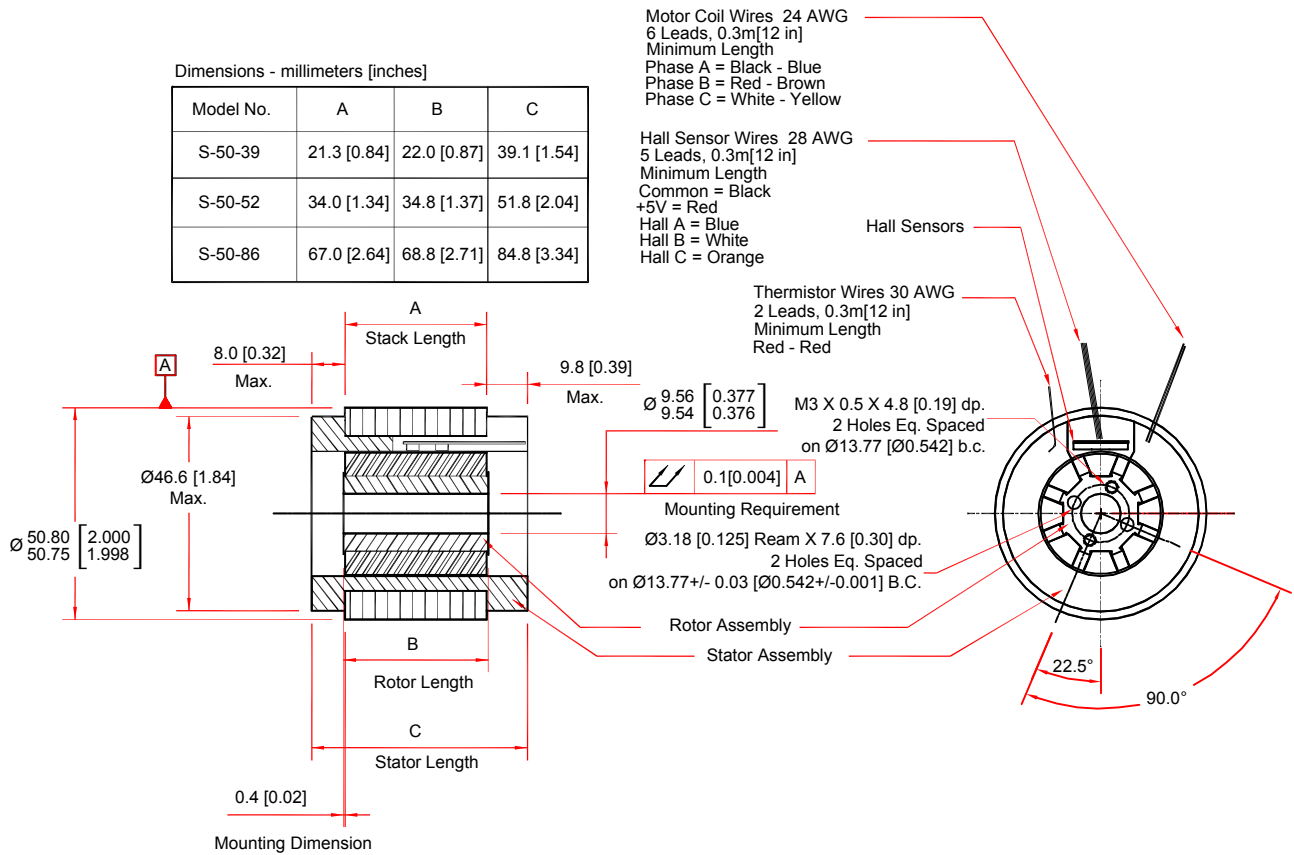

S Series Dimensions

S-76

Dimensions - millimeters [inches]

Model No.	A	B	C
S-76-35	17.2[0.68]	18.8[0.74]	35.0[1.38]
S-76-85	67.0[2.64]	68.6[2.70]	84.8[3.34]
S-76-149	131.0[5.16]	135.0[5.31]	148.8[5.86]

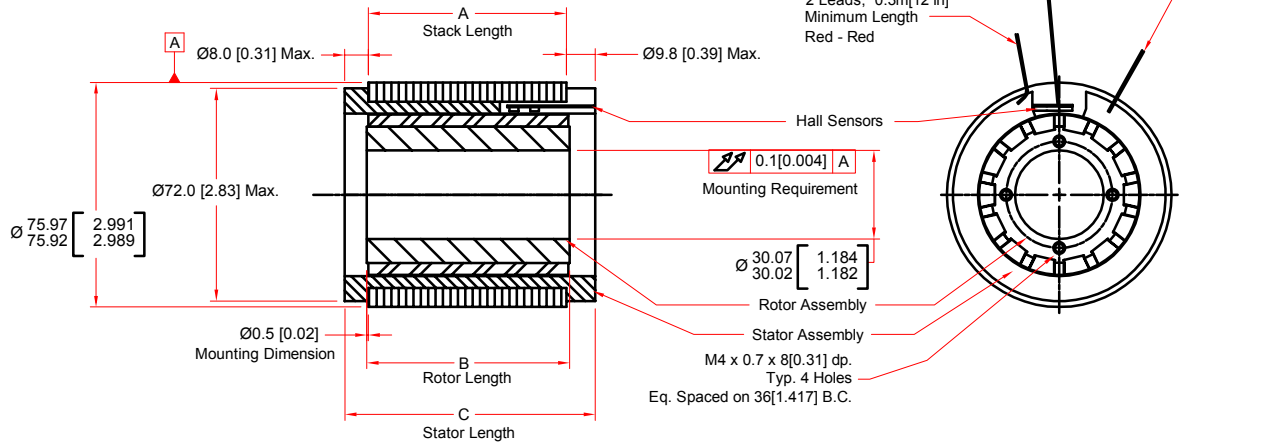

S-130

Dimensions - millimeters [inches]

Model No.	A	B	C
S-130-39	21.0 [0.82]	23.1 [0.91]	38.7 [1.52]
S-130-60	42.0 [1.65]	44.1 [1.74]	59.7 [2.35]
S-130-102	84.0 [3.30]	86.1 [3.39]	101.7 [4.00]

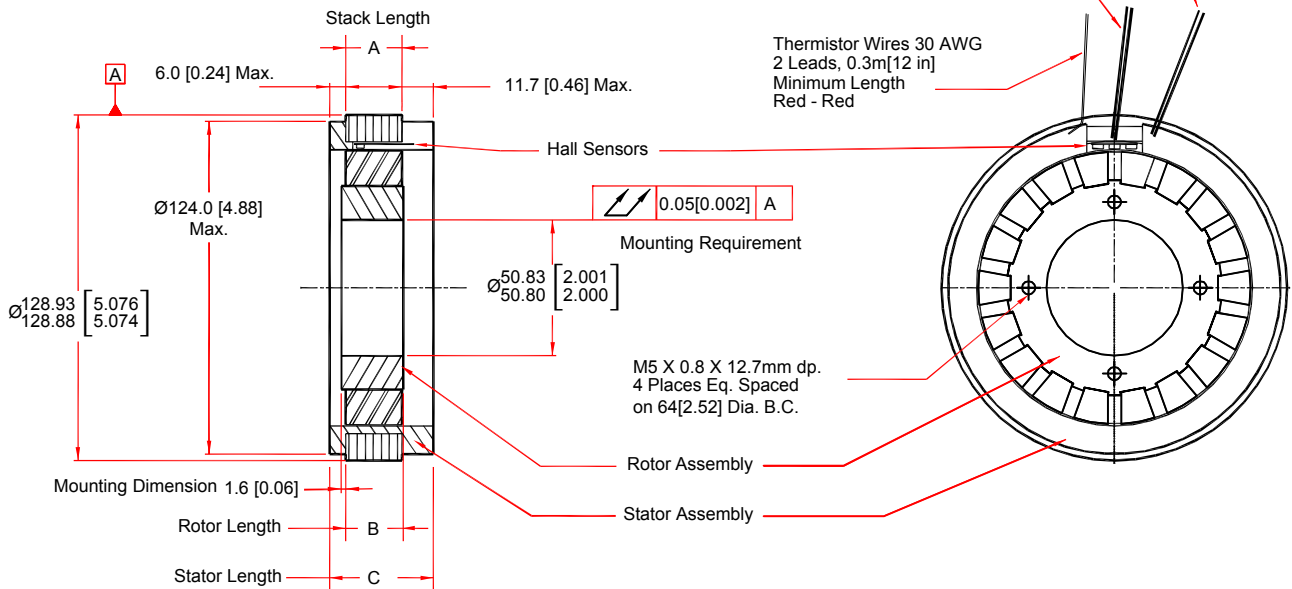

S Series Dimensions

S-180

Dimensions - millimeters [inches]

Model No.	A	B	C
S-180-44	25.0 [0.98]	26.0 [1.02]	43.2 [1.70]
S-180-69	50.0 [1.97]	51.0 [2.01]	68.2 [2.69]
S-180-94	75.0 [2.95]	76.0 [2.99]	93.2 [3.67]

Motor Coil Wires 24AWG
 6 Leads, 0.3m[12 in]
 Minimum Length
 Phase A = Black - Blue
 Phase B = Red - Brown
 Phase C = White - Yellow

Hall Sensor Wires 28 AWG
 5 Leads, 0.3m[12 in]
 Minimum Length
 Common = Black
 +5V = Red
 Hall A = Blue
 Hall B = White
 Hall C = Orange

Thermistor Wires 30 AWG
 2 Leads, 0.3m[12 in]
 Minimum Length
 Red - Red

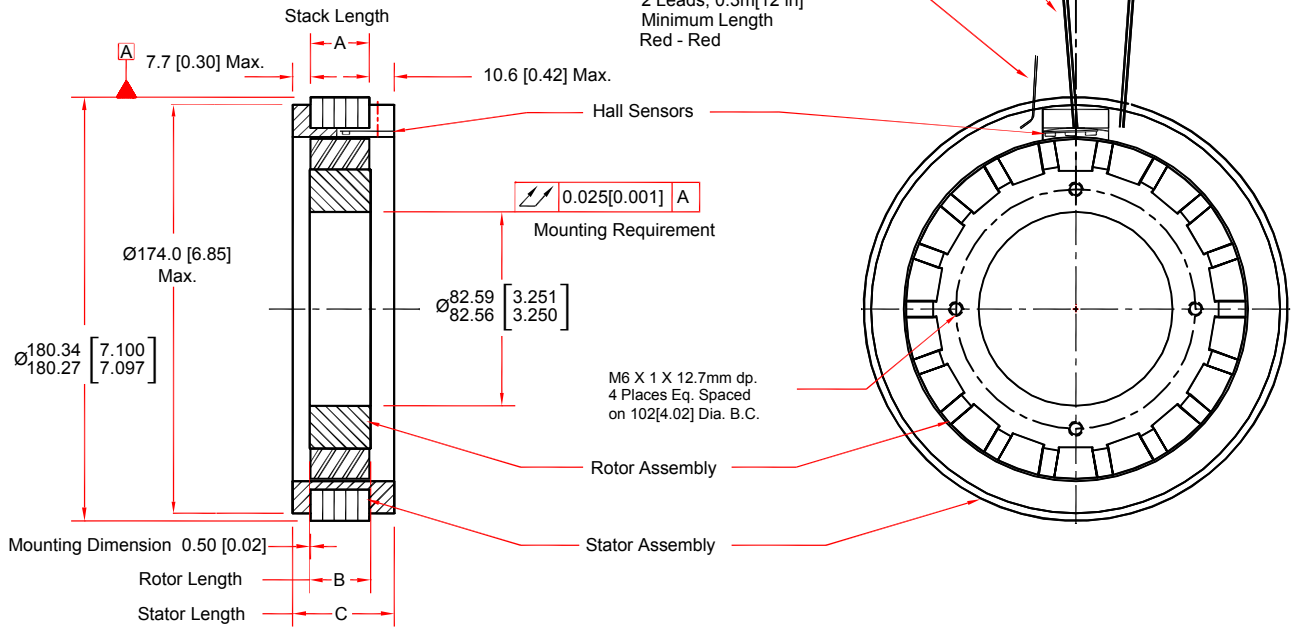

S Series Dimensions

S-240

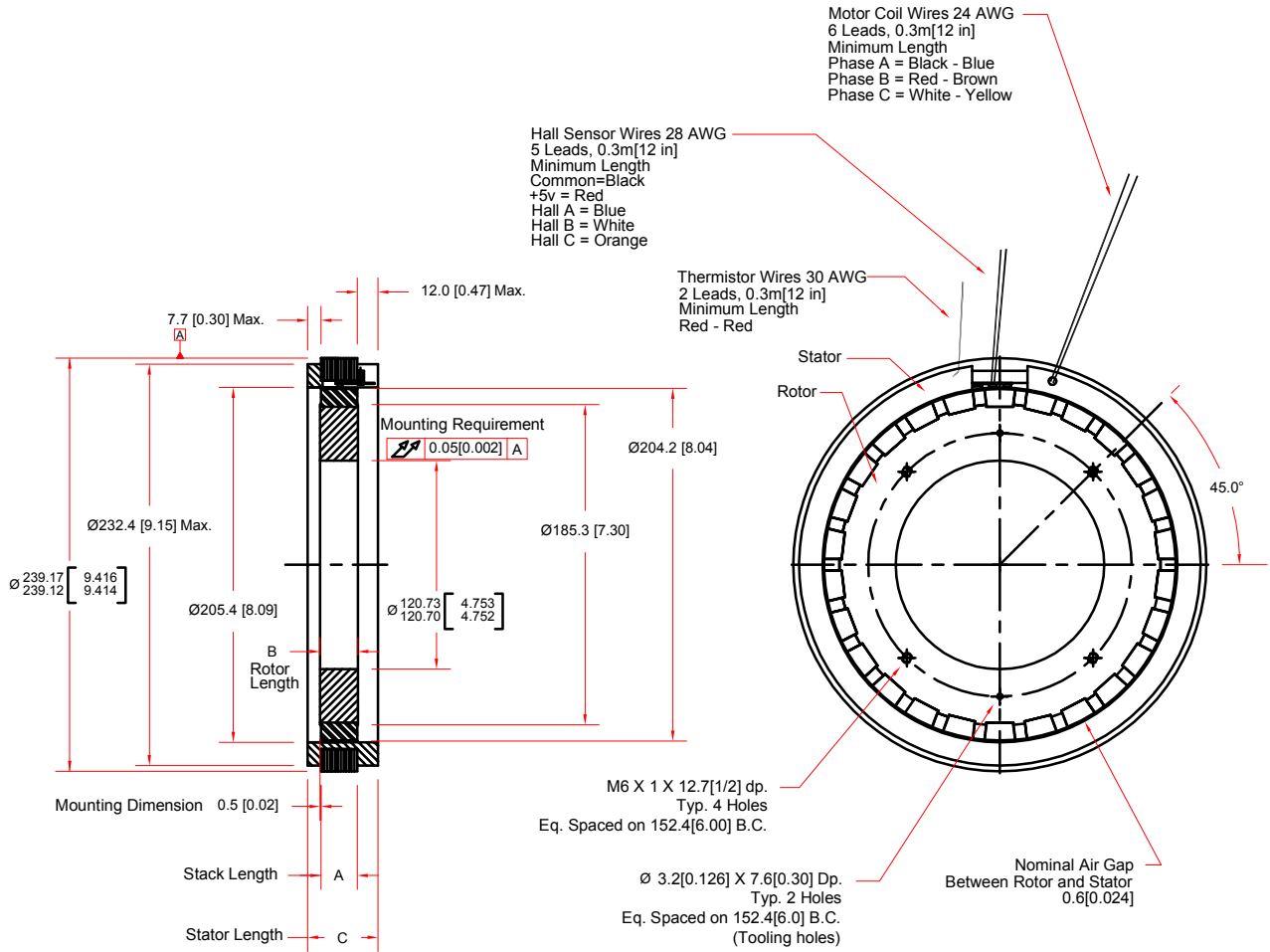

S Series **Ordering Information**

NEMA Brushless Slotless Rotary Servomotor

S-50-39	Slotless motor, rotor, and stator, 50 mm O.D., 39 mm length.
S-50-52	Slotless motor, rotor, and stator, 50 mm O.D., 52 mm length.
S-50-86	Slotless motor, rotor, and stator, 50 mm O.D., 86 mm length.
S-76-35	Slotless motor, rotor, and stator, 76 mm O.D., 35 mm length.
S-76-85	Slotless motor, rotor, and stator, 76 mm O.D., 85 mm length.
S-76-149	Slotless motor, rotor, and stator, 76 mm O.D., 149 mm length.
S-130-39	Slotless motor, rotor, and stator, 130 mm O.D., 39 mm length.
S-130-60	Slotless motor, rotor, and stator, 130 mm O.D., 60 mm length.
S-130-81	Slotless motor, rotor, and stator, 130 mm O.D., 81 mm length.
S-130-102	Slotless motor, rotor, and stator, 130 mm O.D., 102 mm length.
S-130-123	Slotless motor, rotor, and stator, 130 mm O.D., 123 mm length.
S-180-44	Slotless motor, rotor, and stator, 180 mm O.D., 44 mm length.
S-180-69	Slotless motor, rotor, and stator, 180 mm O.D., 69 mm length.
S-180-94	Slotless motor, rotor, and stator, 180 mm O.D., 94 mm length.
S-240-43	Slotless motor, rotor, and stator, 240 mm O.D., 43 mm length.
S-240-63	Slotless motor, rotor, and stator, 240 mm O.D., 63 mm length.
S-240-83	Slotless motor, rotor, and stator, 240 mm O.D., 83 mm length.

Note: S-Series torque ring motors include the stator w/flying leads, adjustable-phase Hall bd., and rotor w/magnets

Winding Designation (Required)

-A Motor winding

Note: Contact factory to inquire about or check availability of alternate winding options.

Integration (Required)

Aerotech offers both standard and custom integration services to help you get your system fully operational as quickly as possible. The following standard integration options are available for this system. Please consult Aerotech if you are unsure what level of integration is required, or if you desire custom integration support with your system.

-TAS	Integration - Test as system Testing, integration, and documentation of a group of components as a complete system that will be used together (ex: drive, controller, and stage). This includes parameter file generation, system tuning, and documentation of the system configuration.
-TAC	Integration - Test as components Testing and integration of individual items as discrete components. This is typically used for spare parts, replacement parts, or items that will not be used or shipped together (ex: stage only). These components may or may not be part of a larger system.