

# ANT130V-5 Series

## Single-Axis Lift Direct-Drive Nanopositioning Stage, 5 mm Travel

Nanometer performance with  
5 mm vertical travel

High resolution (2 nm), repeatability (100 nm),  
and accuracy (200 nm)

In-position stability of <2 nm

Anti-creep crossed-roller bearings

High dynamic performance



### Introduction

Aerotech's ANT series stages are the world's first nanometer-level positioning systems with multi-millimeter travel. The ANT130V-5 and ANT130V-5-PLUS are linear-motor-driven wedge-style vertical lift stages. The stages are designed to be seamlessly integrated with other stages in the ANT130 family for superior multi-axis performance, and are offered in two accuracy grades.

### Noncontact Direct-Drive Design

All of the original ANT series' direct-drive advantages have been preserved in the ANT130V-5 family. Only noncontact direct-drive technology offers the robust, accurate, and high-speed positioning necessary for mass production of precision devices. ANT130-V stages utilize advanced direct-drive technology pioneered by Aerotech to achieve the highest level of positioning performance. This direct-drive technology is high-performance, non-cogging, noncontact, high-speed, high-resolution, and high-accuracy. This unique drive and bearing combination, packaged in an extremely small-profile and footprint, offers tangible advantages in many applications such as high-precision positioning, disk-drive fabrication, fiber alignment, optical delay element actuation, sensor testing, and scanning processes that demand smooth and precise motion.

### Flexible System Design

The ANT130V-5 family has universal mounting and tabletop patterns that allow for easy system integration. Two, three, or more axes can be combined easily for flexible system designs and multi-axis configurations.

### System Characteristics

Outstanding accuracy, position repeatability, and in-position stability require high system resolution. The ANT130V-5 stage's industry-leading 2 nm minimum incremental step size provides this high level of performance. Excellent in-position stability is assisted by high-quality, anti-creep, crossed-roller bearings. The stage offers virtually maintenance-free operation over the life of the product. Aerotech's direct-drive technology has no hysteresis or backlash, enabling accurate and repeatable nanometer-scale motion.

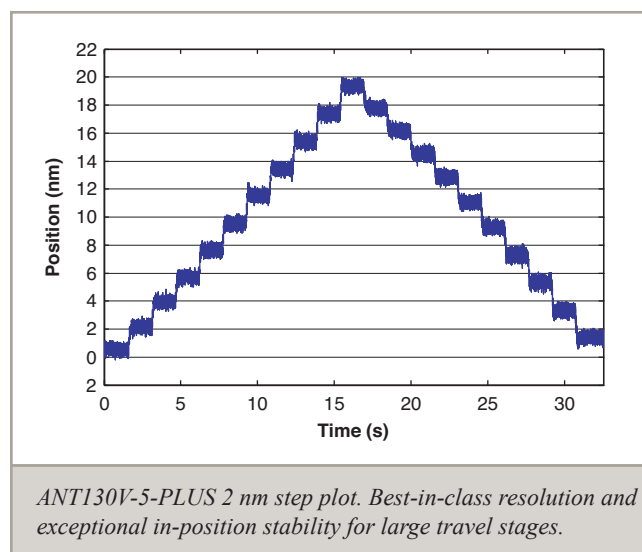

## ANT130V-5 SPECIFICATIONS

Mechanical Specifications	ANT130V-5	
Travel	5 mm	
Accuracy <sup>(1)</sup>	Base Performance (-PL1)	±2 µm (± 80 µin)
	PLUS Performance (-PL2)	±200 nm (± 8 µin)
Resolution (Minimum Incremental Motion)	2 nm (± 0.08 µin)	
Repeatability (Bi-Directional) <sup>(1)</sup>	Base Performance (-PL1)	±150 nm (± 6 µin)
	PLUS Performance (-PL2)	±100 nm (± 4 µin)
Repeatability (Uni-Directional)	±75 nm (± 3 µin)	
Straightness <sup>(2)</sup>	±1.0 µm (±40 µin)	
Pitch <sup>(1)</sup>	20 arc sec	
Roll	10 arc sec	
Yaw <sup>(1)</sup>	10 arc sec	
Maximum Speed	75 mm/s (3 in/s)	
Maximum Acceleration	0.7 g - 7 m/s <sup>2</sup> (No Load)	
Settling Time	See graphs for typical performance	
In-Position Stability <sup>(3)</sup>	<2 nm (<0.08 µin)	
Maximum Force (Continuous)	100 N	
Load Capacity <sup>(4)</sup>	3.0 kg (6.6 lb)	
Moving Mass	1.8 kg (4 lb)	
Stage Mass	3.1 kg (7 lb)	
Material	Aluminum Body/Black Hardcoat Finish/Black Anodize Finish	
MTBF (Mean Time Between Failure)	30,000 Hours	

## Notes:

- Certified with each stage.
  - Measured perpendicular or parallel to wedge direction.
  - In-Position Stability listing is 3 sigma value.
  - Assumes loading along axis of travel.
- Specifications are per axis, measured 25 mm above the tabletop. Performance of multi-axis systems is payload and workpoint dependent. Consult factory for multi-axis or non-standard applications.
  - PLUS requires the use of an Aerotech controller

Electrical Specifications	ANT130V-5
Drive System	Brushless Linear Servomotor
Feedback	Noncontact Linear Encoder
Maximum Bus Voltage	-CN1: 80 VDC, -CN2: 160 VDC
Limit Switches	5 V, Normally Closed
Home Switch	Near Center

Note: To ensure the achievement and repeatability of specifications over an extended period of time, environmental temperature must be controlled to within 0.25°C/24 hours. If this is not possible, alternate products are available. Please consult Aerotech Application Engineering for more information.

## ANT130V-5 PERFORMANCE

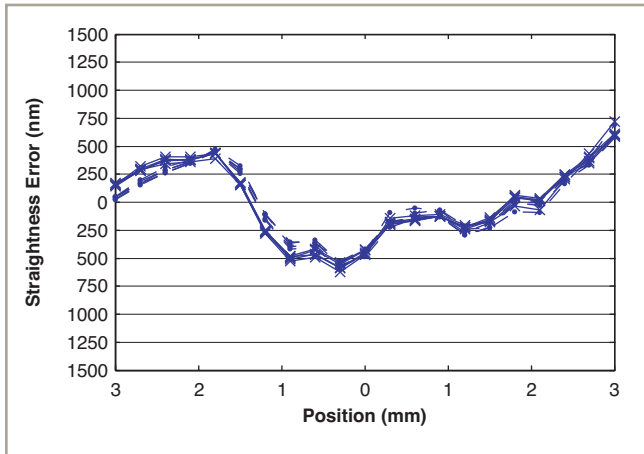

*ANT130V-5-PLUS straightness error; five runs, bi-directional, parallel to the wedge.*

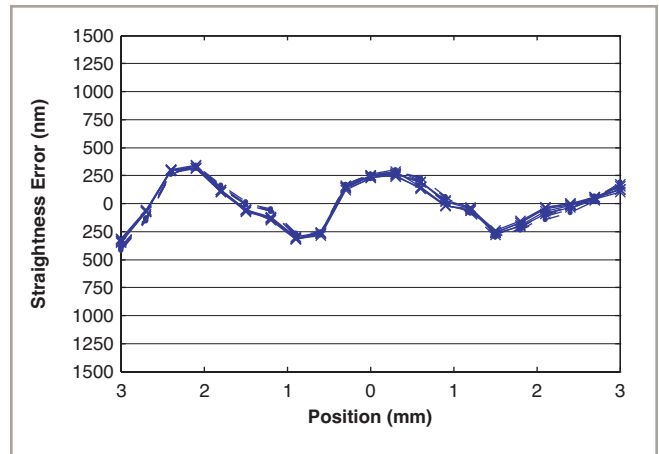

*ANT130V-5-PLUS straightness error; five runs, bi-directional, perpendicular to the wedge.*

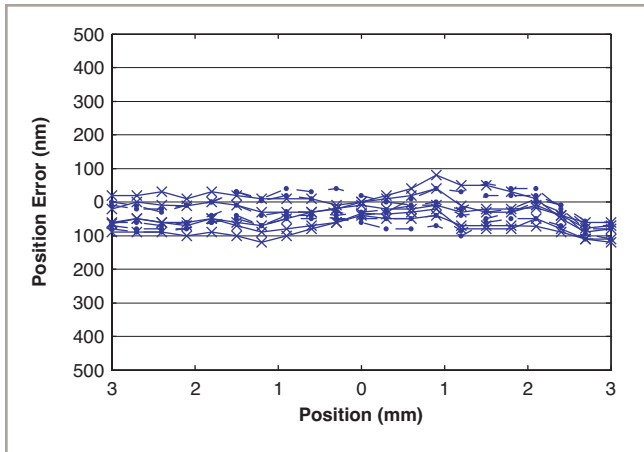

*ANT130V-5-PLUS accuracy and repeatability. This multiple test run over an extended period of time shows the high level of system accuracy and repeatability.*

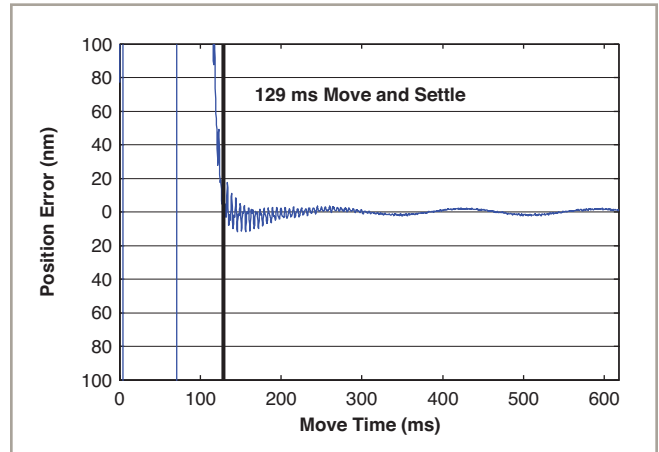

*ANT130V-5-PLUS step and settle performance at 75 mm/s, with a settle spec of  $\pm 20$  nm, and a step size of 5 mm. Outstanding settling time enhances throughput of most applications.*

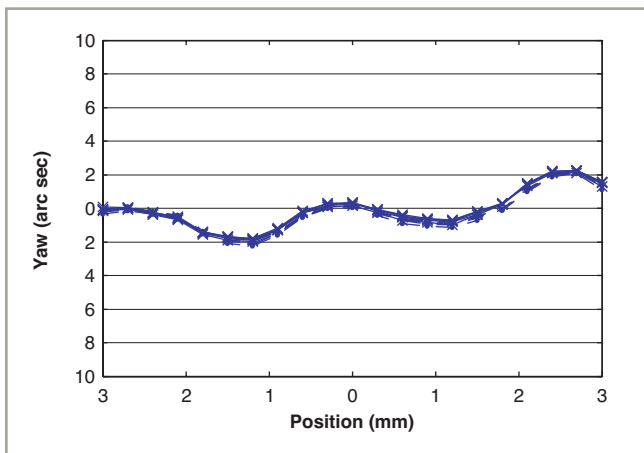

*ANT130V-5-PLUS yaw, five runs, bi-directional. Highly repeatable, minimal yaw error enhances system positioning accuracy.*

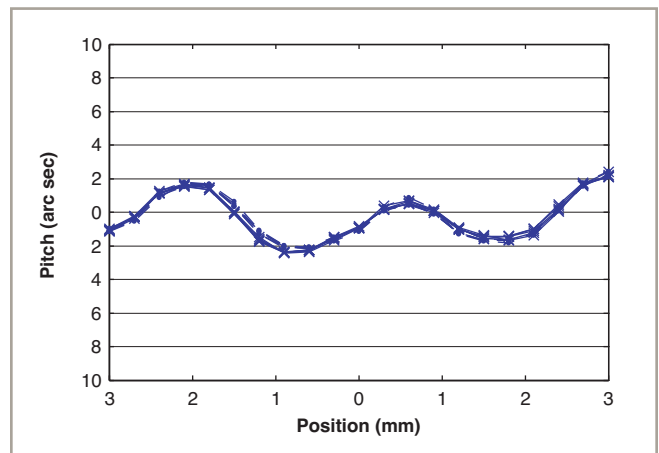

*ANT130V-5-PLUS pitch, five runs, bi-directional. Excellent repeatability/accuracy contribute to improved processing.*

ANT130V-5 DIMENSIONS

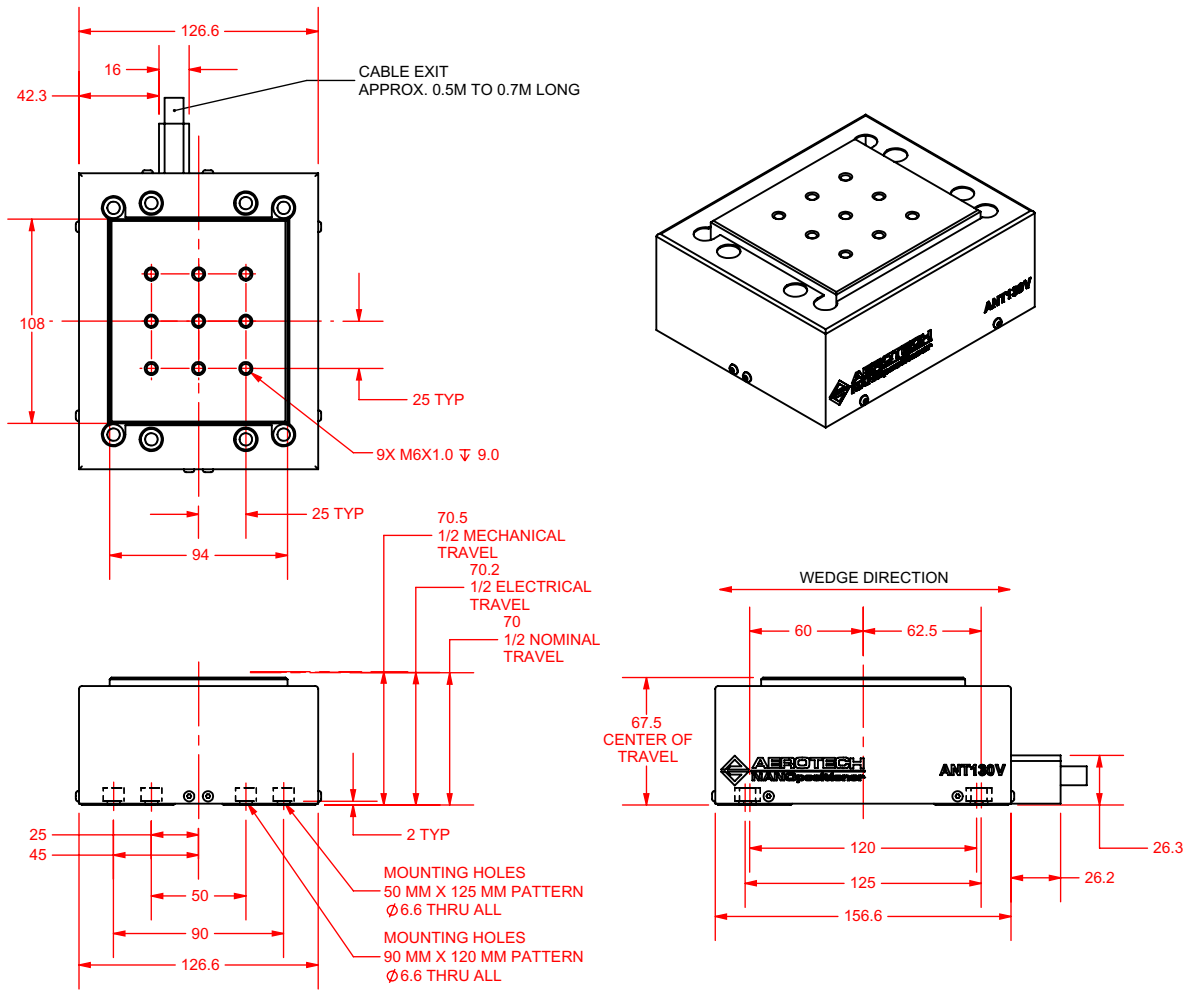

## ANT130V-5 Mounting Plate DIMENSIONS

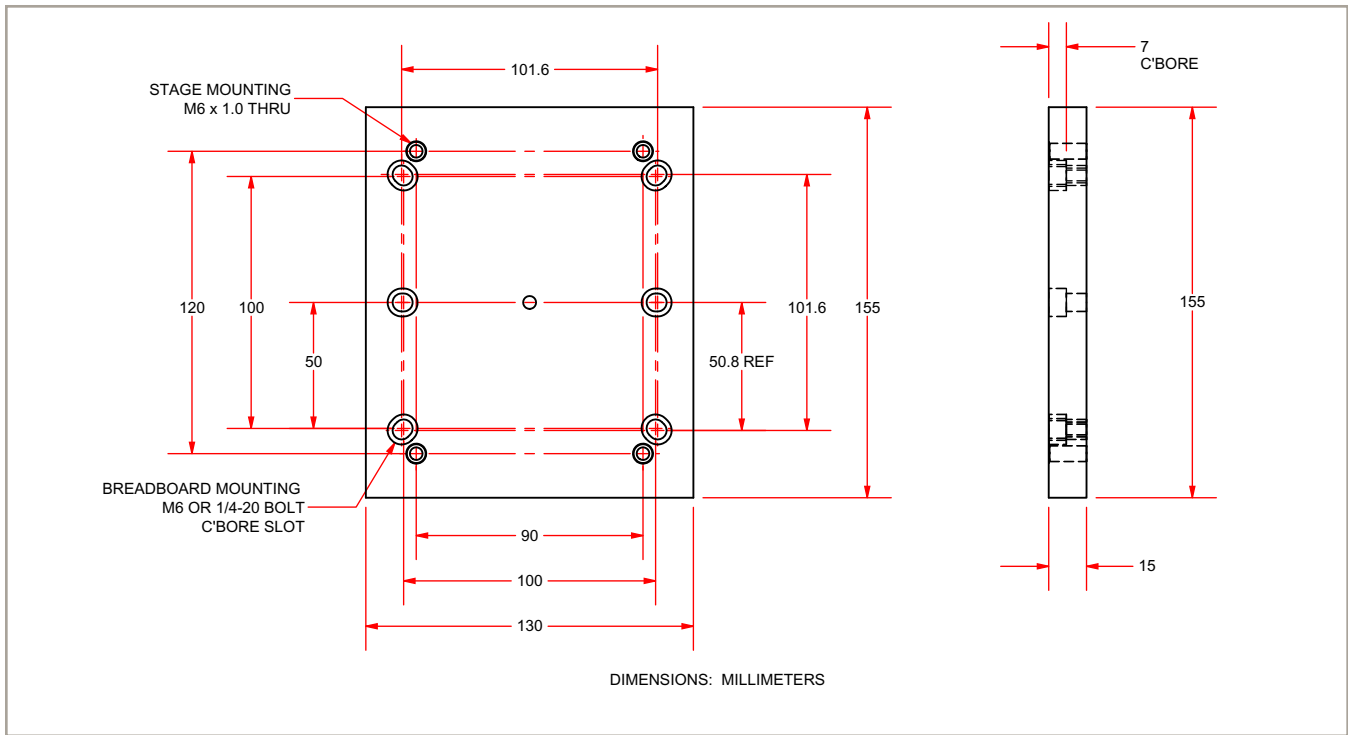

## ANT130V-5 ORDERING INFORMATION

### Connector (Required)

-CN1	Single connector, 25DU for motor/Fbk
-CN2	Two connectors, 4DU motor, 25DU Fbk

Note: -25DU single 25-pin connector option not valid for systems using bus voltages greater than 80 V.

### Mounting Plate (Optional)

-MP	Mounting plate
-----	----------------

### Performance Grade (Required)

-PL1	Base performance
-PL2	High-accuracy performance, PLUS

### Integration (Required)

Aerotech offers both standard and custom integration services to help you get your system fully operational as quickly as possible. The following standard integration options are available for this system. Please consult Aerotech if you are unsure what level of integration is required, or if you desire custom integration support with your system.

-TAS	<p>Integration - Test as system</p> <p>Testing, integration, and documentation of a group of components as a complete system that will be used together (ex: drive, controller, and stage). This includes parameter file generation, system tuning, and documentation of the system configuration.</p>
-TAC	<p>Integration - Test as components</p> <p>Testing and integration of individual items as discrete components that ship together. This is typically used for spare parts, replacement parts, or items that will not be used together. These components may or may not be part of a larger system.</p>