

LINEAR STAGES **ATX115SL/SLE SERIES**

Available with
ThermoComp™



This is one of 12 models in the ATX-SL(E) series of ball-screw-driven, crossed-roller bearing linear stages.

Aerotech's ATX115SL and ATX115SLE linear positioning stages combine the performance capabilities of a high-precision crossed-roller-bearing positioner with the convenience and simplicity of a ball-screw drive mechanism. Outstanding motion performance and a variety of advanced options and features offer superb value and make the ATX115SL/SLE an excellent choice to use in high-performance applications.

Superior Motion Performance

Featuring anti-creep crossed-roller bearings and a precision-ground, fine-pitch ball-screw, the ATX115SL/SLE boasts excellent geometric performance and minimal angular error motion. With up to 150 mm of nominal travel, the ATX115SL/SLE offers superior minimum incremental step size and in-position stability compared to other stages that utilize recirculating ball bearings. This makes the ATX115SL/SLE ideal for many high-precision tasks such as vertical positioning of sensors and cameras, optics focusing, and beamline measurement and manipulation applications.

Linear Encoder Option

The ATX115SLE offers an integral center-mounted linear encoder

to provide direct position measurement at the stage's moving carriage. The typical effects of backlash commonly associated with screw drives are virtually eliminated when using the linear encoder as a position feedback device. Applications that require exacting workpoint performance benefit greatly from the ATX115SLE's direct linear encoder. Options are available with either incremental (1 Vpp and digital TTL) or absolute output signals.

Design and Integration Flexibility

The ATX115SL/SLE is designed with a variety of standard features and available options allowing it to be easily integrated into a larger subsystem or machine, or to serve as a stand-alone positioning axis. It mounts to both metric and English optical tables and features a versatile customer mounting interface on the moving carriage to which other positioning stages or equipment can be mounted. Brushless, slotless servomotors, with or without a holding brake, as well as stepper motors, are available options. The ATX115SL/SLE can be equipped with an optional motor foldback kit in order to reduce the overall length of the stage. This is particularly useful in vertical-axis applications

— PRODUCT HIGHLIGHTS —

Travel lengths up to 150 mm with anti-creep crossed-roller bearings

Optional center-mounted linear encoder for direct position feedback

Versatile features and options enable convenient integration into a larger machine or use as a stand-alone positioning axis

Vacuum- and cleanroom-compatible versions available

Available with ThermoComp™ for reliable performance in changing environments

where space is limited. Vacuum- and cleanroom-compatible variants are also available.

Mitigate Thermal Errors with ThermoComp™

Temperature changes and thermal effects are often the most detrimental sources of error in precision machines, and screw drives are particularly susceptible. All ATX-series stages are

available with Aerotech's ThermoComp™ feature, an integrated temperature compensation solution that delivers accurate and dependable positioning performance in the presence of thermal disturbances. It protects the stage from the effects of variable-temperature environments and friction-induced self-heating, ultimately providing stability to the user's process, even in extreme industrial environments.

ATX115SL/SLE Series Specifications

Mechanical Specifications			ATX115SL/ATX115SLE		
Travel			50 mm	100 mm	150 mm
Accuracy ¹	SL	Uncalibrated	±6 µm		
		Calibrated ²	±0.75 µm	±1 µm	±1 µm
	SLE	Uncalibrated	±2 µm	±3 µm	±4 µm
		Calibrated ²	±0.5 µm	±0.6 µm	±0.6 µm
Resolution (Minimum Incremental Motion)		SL	0.05 µm ³ 0.1 µm ⁴		
		SLE	0.025 µm (-E1 feedback option) ⁵ 0.1 µm (-E2 feedback option) 0.2 µm (-E3 feedback option)		
Bidirectional Repeatability ¹		SL	±0.5 µm		
		SLE	±0.15 µm	±0.2 µm	±0.2 µm
Horizontal Straightness ¹			±1.25 µm	±1.5 µm	±1.75 µm
Vertical Straightness ¹			±1.25 µm	±1.5 µm	±1.75 µm
Pitch			60 µrad (12 arc-sec)	70 µrad (14 arc-sec)	80 µrad (16 arc-sec)
Yaw			40 µrad (8 arc-sec)	50 µrad (10 arc-sec)	60 µrad (12 arc-sec)
Maximum Speed ⁶	2.0 mm/rev Ball Screw	DC Motor (-M1, -M2)	100 mm/s	100 mm/s	100 mm/s
		DC Motor (-M3, -M4)	220 mm/s	220 mm/s	220 mm/s
		Stepper Motor (-M5)	60 mm/s	60 mm/s	60 mm/s
Load Capacity		Horizontal	14 kg		
		Side	10 kg		
		Vertical (Axial)	7 kg		
Moving Mass			0.8 kg	1.0 kg	1.3 kg
Stage Mass			3.2 kg	3.8 kg	4.5 kg
Material			Anodized aluminum		

1 Certified with each stage.
 2 Available with Aerotech controllers.
 3 Achieved with Aerotech rotary motor with amplified sine encoder. Specification is unidirectional.
 4 Achieved with Aerotech rotary motor with 10,000 lines/rev digital encoder. Specification is unidirectional.
 5 Requires motor with 1 Vpp amplified sine encoder (-M3, -M4 motor options) and linear amplifier.
 6 Requires the selection of an appropriate amplifier with sufficient voltage and current.

Electrical Specifications		ATX115SL/ATX115SLE	
Drive		Brushless Rotary Servomotor (-M1 through -M4) Stepper Motor (-M5)	
Feedback (Linear Encoder - SLE Version Only)		Incremental: 1 Vpp (-E1 feedback option) or 0.05 µm TTL (-E2 feedback option) Absolute: EnDat 2.2 (-E3 feedback option)	
Feedback (Rotary Encoder)		Incremental: 10,000-Line TTL (-M1, -M2 motor options) or 1000-Line 1 Vpp (-M3, -M4 motor options)	
Maximum Bus Voltage		48 VDC	
Limit Switches		5 V, Normally Closed	

ATX115SL/SLE Series Specifications

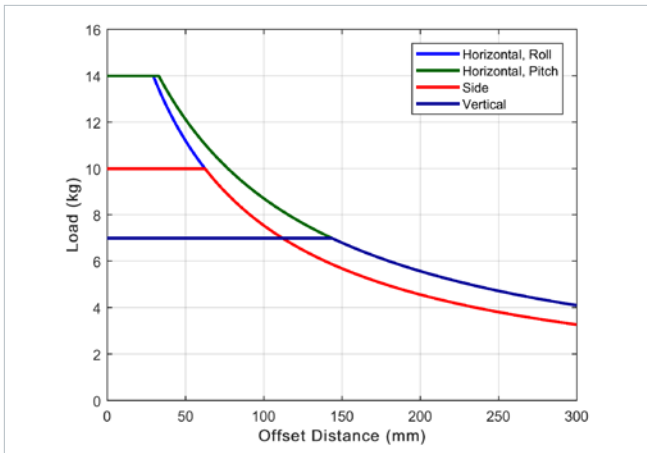

Cantilevered load capability of ATX115SL(E)-050.

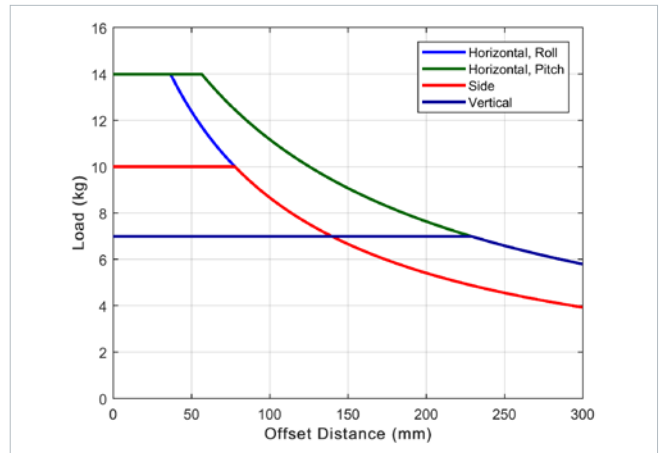

Cantilevered load capability of ATX115SL(E)-100.

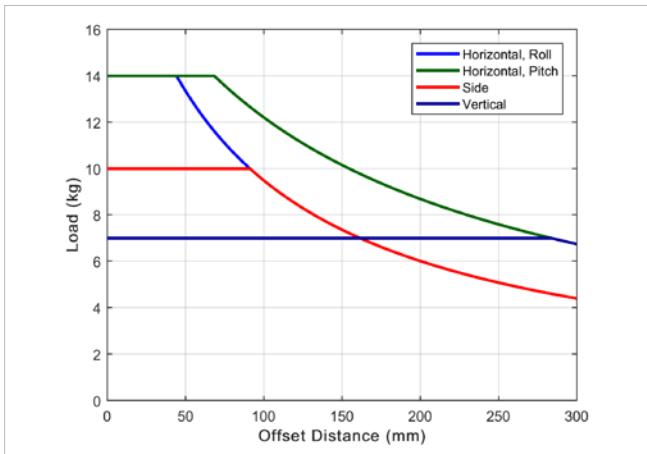

Cantilevered load capability of ATX115SL(E)-150.



ATX115SL stage with 50 mm travel, shown with optional motor foldback kit. The motor foldback kit is advantageous in space-constrained applications.

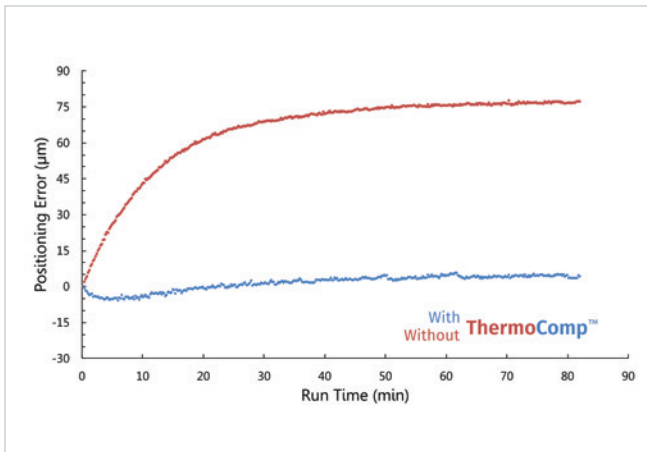

Measurement data showing successful compensation of internal heating-related positioning errors during prolonged operation of a ballscrew stage using the ThermoComp feature. Results are typical of ball screw stage performance with and without ThermoComp.

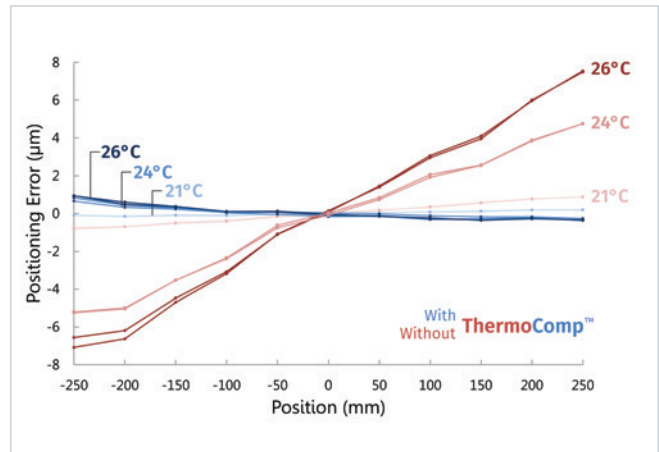

Measurement data showing successful compensation of thermal-related positioning errors at several temperatures using the ThermoComp feature. Results are typical of stage performance with and without ThermoComp.

ATX115SL/SLE Series Dimensions

STANDARD MOTOR CONFIGURATION

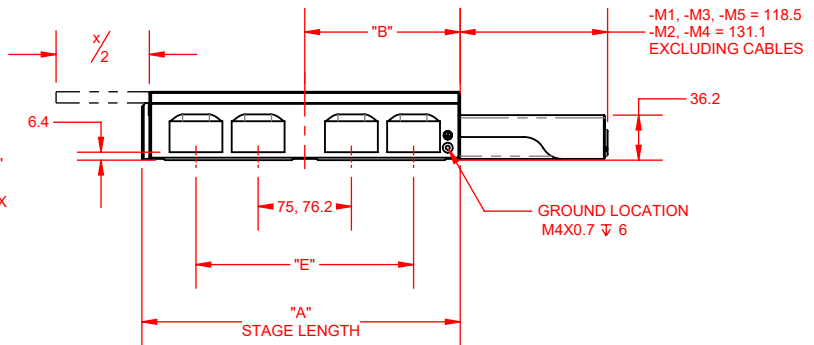
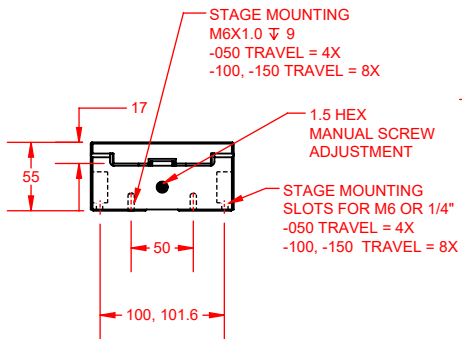
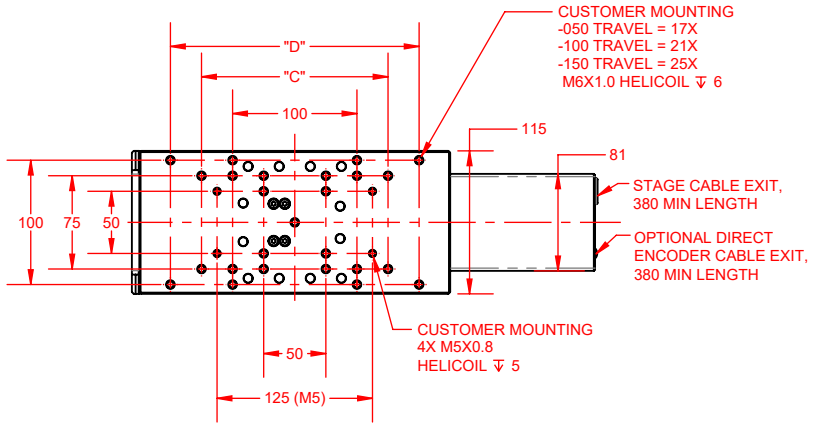
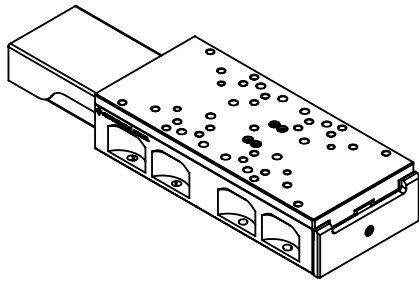

FOLDBACK MOTOR CONFIGURATION

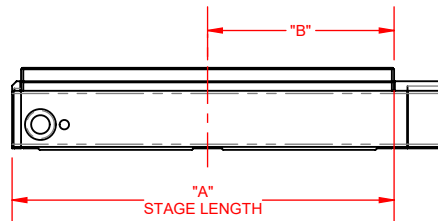
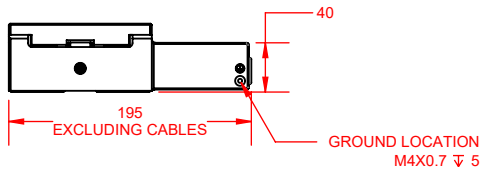
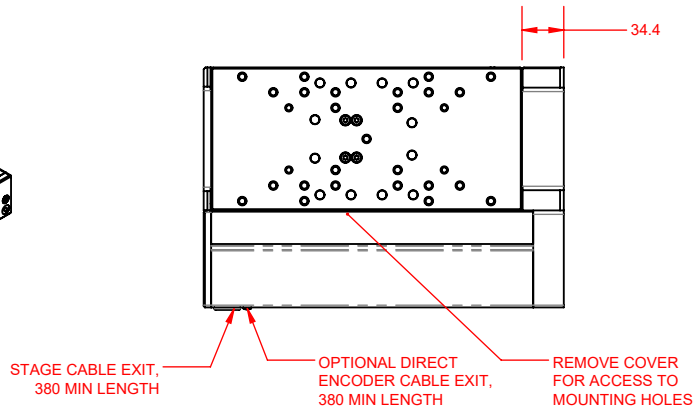
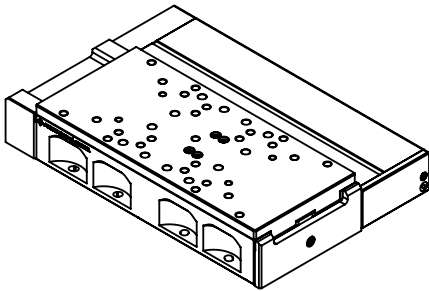

BASIC MODEL	NOMINAL TRAVEL x	ELEC LIMIT TRAVEL	MECH LIMIT TRAVEL	A	B	C	D	E
ATX115SL-050	50	53	57	156	75	-	-	-
ATX115SL-100	100	103	107	206	100	150	-	125, 127
ATX115SL-150	150	153	157	256	125	150	200	175, 177.8

NOTES:

1. DIMENSIONS: MILLIMETERS.

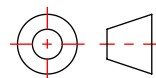

ATX115SSL/SLE Series **Ordering Information**

Direct Linear Feedback (Required)

SL	No direct linear feedback
SLE-E1	Incremental linear encoder, 1 Vpp
SLE-E2	Incremental linear encoder, 0.05 μ m digital TTL output
SLE-E3	Absolute linear encoder

Travel (Required)

-050	50 mm travel
-100	100 mm travel
-150	150 mm travel

Motor (Required)

-M1	DC servomotor with 10,000-line TTL encoder
-M2	DC servomotor with 10,000-line TTL encoder and brake
-M3	DC servomotor with 1000-line 1 Vpp encoder
-M4	DC servomotor with 1000-line 1 Vpp encoder and brake
-M5	Stepper motor

Foldback Kit (Optional)

-FB1	Foldback kit for ATX115 motor
------	-------------------------------

ThermoComp (Optional)

-TCMP	ThermoComp integrated thermal compensation
-------	--

Metrology (Required)

-PL1	Metrology, uncalibrated with performance plots
-PL2	Metrology, calibrated (HALAR) with performance plots

Integration (Required)

Aerotech offers both standard and custom integration services to help you get your system fully operational as quickly as possible. The following standard integration options are available for this system. Please consult Aerotech if you are unsure what level of integration is required, or if you desire custom integration support with your system.

-TAS	Integration - Test as system Testing, integration, and documentation of a group of components as a complete system that will be used together (ex: drive, controller, and stage). This includes parameter file generation, system tuning, and documentation of the system configuration.
-TAC	Integration - Test as components Testing and integration of individual items as discrete components. This is typically used for spare parts, replacement parts, or items that will not be used or shipped together (ex: stage only). These components may or may not be part of a larger system.