



Single-Axis Linear Nanopositioning Stages **ANT130L**

Achieve Superior Nanometer-Scale Motion

Our second-generation ANT130L linear stages are the leading solution for addressing your nanometer-level motion and positioning needs. Available in a variety of configurations, they excel at delivering superior accuracy, repeatability, speed and reliability. Their impressive dynamic capabilities and ample load capacity make ANT130L stages an excellent choice for your high-precision industrial or research process.

Key Applications

ANT130L stages are ideal for high-precision and high-dynamic positioning applications, including:

- ◆ Photonics assembly & inspection
- ◆ Fiber alignment & optimization
- ◆ Optics manufacturing, testing & inspection
- ◆ Sensor testing & qualification
- ◆ Semiconductor processing & inspection
- ◆ Research & laboratory applications

KEY FEATURES:

- ◆ Enhanced second-generation design
- ◆ Delivers **NANOMETER-LEVEL POSITIONING PERFORMANCE** over travel lengths up to **210 mm - NEW**
- ◆ Achieves **MINIMUM INCREMENTAL MOTION TO 0.5 nm - NEW**
- ◆ Features high-precision crossed-roller bearings for **EXCELLENT DYNAMIC PERFORMANCE & AMPLE LOAD CAPACITY**
- ◆ **MAXIMIZES PROCESS THROUGHPUT & RELIABILITY** with ironless direct-drive linear motor
- ◆ Integrates easily into **MULTI-AXIS ASSEMBLIES** & motion subsystems
- ◆ **ABSOLUTE** and **ULTRA-HIGH RESOLUTION** incremental encoder options are available

ANT130L SERIES SPECIFICATIONS

Mechanical Specifications		ANT130L-035	ANT130L-060	ANT130L-110	ANT130L-160	ANT130L-210
Travel		35 mm	60 mm	110 mm	160 mm	210 mm
Accuracy ⁽¹⁾	Base Performance (-PL1)	± 2.0 µm		± 3.0 µm	± 4.0 µm	
	Plus Performance (-PL2)	± 250 nm (-E1, -E2, -E3) ± 175 nm (-E4)		± 275 nm (-E1, -E2, -E3) ± 200 nm (-E4)		± 300 nm (-E1, -E2, -E3) ± 225 nm (-E4)
Repeatability (Bidirectional) ⁽¹⁾		±75 nm				
Resolution (Minimum Incremental Motion)		1 nm (-E1) 5 nm (-E3) 0.5 nm (-E4)				
Straightness ⁽¹⁾		± 1.0 µm			± 1.5 µm	
Flatness ⁽¹⁾		± 1.0 µm			± 1.5 µm	
Pitch		10 arc sec				
Roll		10 arc sec				
Yaw		5 arc sec				
Maximum Speed ⁽²⁾		350 mm/s (-E1, -E3, -E4) 145 mm/s (-E2)				
Maximum Acceleration (No Load) ⁽²⁾		1 g				
Speed Stability		See graph for typical performance				
Settling Time		See graph for typical performance				
In-Position Stability ⁽³⁾		<1 nm (-E1) <5 nm (-E3) <0.5 nm (-E4)				
Load Capacity ⁽⁴⁾	Horizontal	12 kg				
	Side	10 kg				
Moving Mass		1.3 kg	1.4 kg	1.9 kg	2.3 kg	2.7 kg
Stage Mass		2.6 kg	3.0 kg	3.8 kg	4.6 kg	5.5 kg
Material		Anodized Aluminum				
MTBF (Mean Time Between Failure)		30,000 Hours				

Notes:

1. Certified with each stage.
2. Requires the selection of an appropriate amplifier with sufficient voltage and current.
3. In-position stability is reported as 3-sigma value. Requires a 1 Vpp encoder.
4. Payload specifications assume payload is centered on-axis.
5. Specifications are reported for a single axis measured 25 mm above the tabletop. Performance of multi-axis systems depends on the payload and workpoint.
Consult factory for multi-axis or non-standard applications.
6. PLUS performance requires the use of an Aerotech controller.
7. To ensure the achievement and repeatability of specifications over an extended period of time, environmental temperature must be controlled to within 0.25°C per 24 hours. Consult factory for more information.

Electrical Specifications	ANT130L-035	ANT130L-060	ANT130L-110	ANT130L-160	ANT130L-210
Drive System	Brushless Linear Servomotor				
Feedback	Noncontact Linear Encoder 1 Vpp with 20 µm signal period (-E1) Digital RS422 (-E2) BiSS-C absolute + incremental 1 Vpp linear dual-track encoder (-E3) 1 Vpp with 4 µm signal period (-E4)				
Maximum Bus Voltage	-CN1: 80 VDC -CN2: 160 VDC				
Limit Switches	5 V, Normally Closed				
Home Switch	Near Center				

ANT130L SERIES ORDERING INFORMATION

Travel (Required)

-035	35 mm travel
-060	60 mm travel
-110	110 mm travel
-160	160 mm travel
-210	210 mm travel

Feedback (Required)

-E1	Incremental linear encoder, 1 Vpp amplified sine output
-E2	Incremental linear encoder, digital RS422 output, 5 nm electrical resolution
-E3	Absolute + Incremental 1 Vpp linear dual-track encoder
-E4	Incremental linear encoder, 1 Vpp amplified sine output, high-performance

Connectors (Required)

-CN1	Single 25-pin D connector, 25DU
-CN2	Two connectors, 4-pin HPD and 25-pin D, 4DU-25DU

Note: The -CN1 option is limited to a maximum bus voltage of 80 V. The -CN2 option is required for higher bus voltages.

Mounting Plate (Optional)

-MP	Mounting plate
-----	----------------

Performance Grade (Required)

-PL1	Base performance
-PL2	High-accuracy performance, PLUS

Integration (Required)

Aerotech offers both standard and custom integration services to help you get your system fully operational as quickly as possible. The following standard integration options are available for this system. Please consult Aerotech if you are unsure what level of integration is required, or if you desire custom integration support with your system.

-TAS Integration - Test as system

Testing, integration, and documentation of a group of components as a complete system that will be used together (ex: drive, controller, and stage). This includes parameter file generation, system tuning, and documentation of the system configuration.

-TAC Integration - Test as components

Testing and integration of individual items as discrete components that ship together. This is typically used for spare parts, replacement parts, or items that will not be used together. These components may or may not be part of a larger system.

ANT130L SERIES SPECIFICATIONS

ANT130L SERIES PERFORMANCE

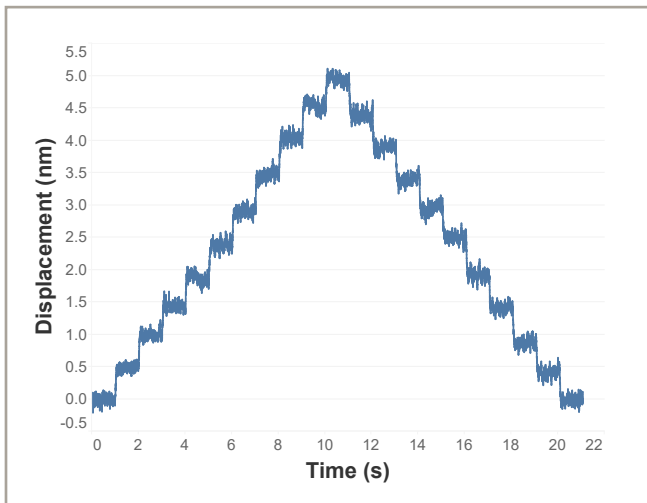

ANT130L-210-E4-PL2 step plot showing 0.5 nm minimum incremental motion. Best-in-class resolution and exceptional in-position stability for large travel stages.

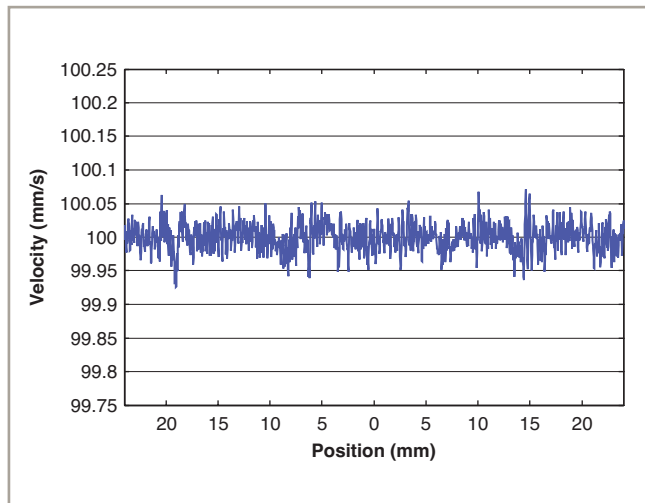

ANT130L-060-E1-PL2 velocity performance at 100 mm/s and 1 kg payload. Excellent speed stability is another feature of the ANT series stages.

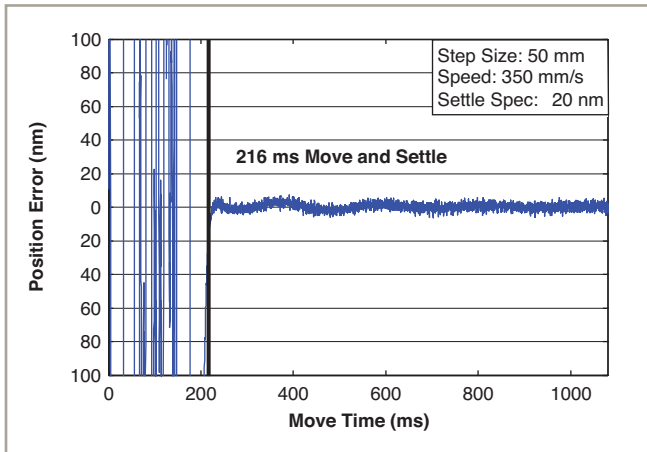

ANT130L-060-E1-PL2 step and settle performance with 1 kg payload. Outstanding settling time enhances throughput of most applications.

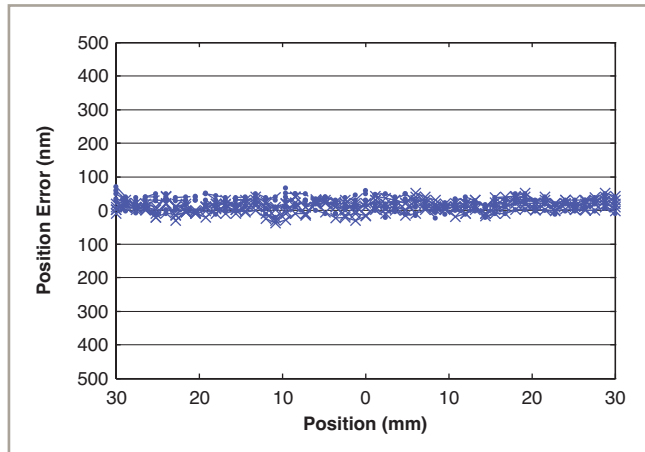

ANT130L-060-E1-PL2 accuracy and repeatability, five runs, bi-directional over an extended period of time shows the high level of system accuracy and repeatability.

ANT130L SERIES SPECIFICATIONS

ANT130L SERIES PERFORMANCE

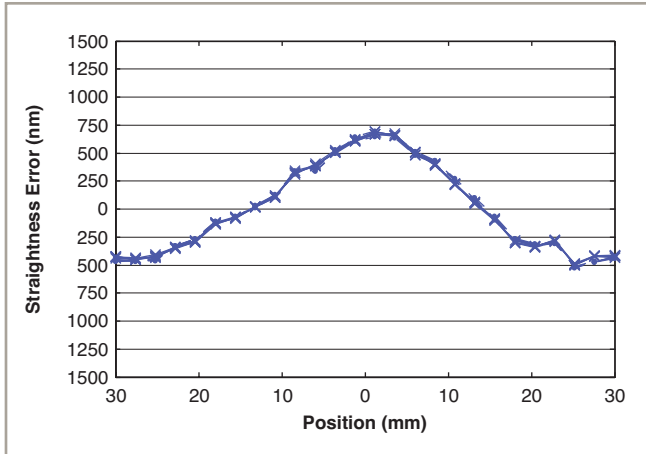

ANT130L-060-E1-PL2 straightness error, bi-directional. Exceptional and highly repeatable performance is assured with minimal straightness error.

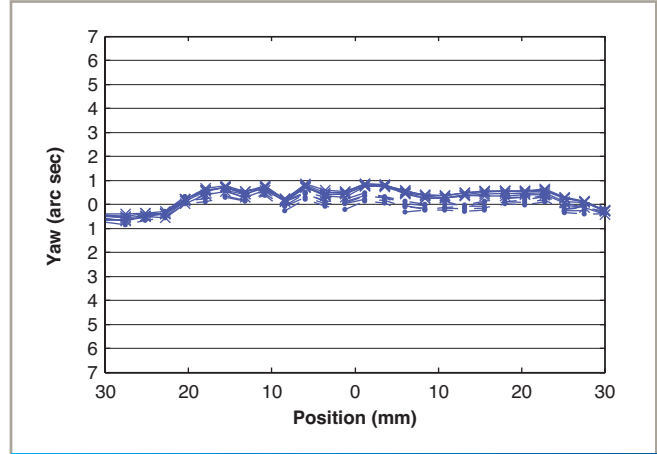

ANT130L-060-E1-PL2 yaw, five runs, bi-directional. Highly repeatable, minimal yaw error enhances system positioning accuracy.

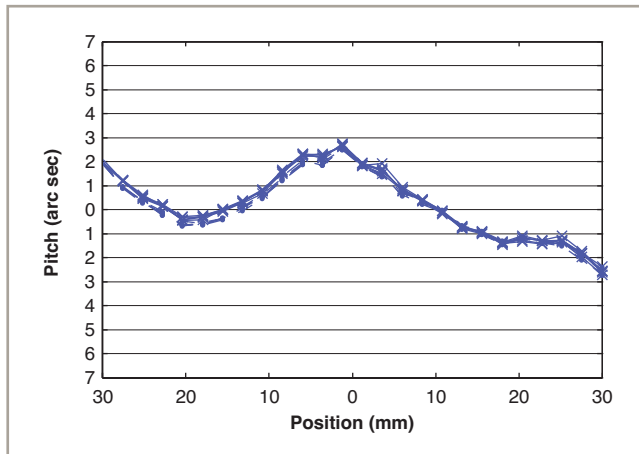

ANT130L-060-E1-PL2 pitch, five runs, bi-directional. Excellent repeatability/accuracy contribute to improved processing.

ANT130L DIMENSIONS

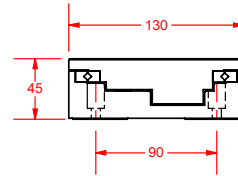
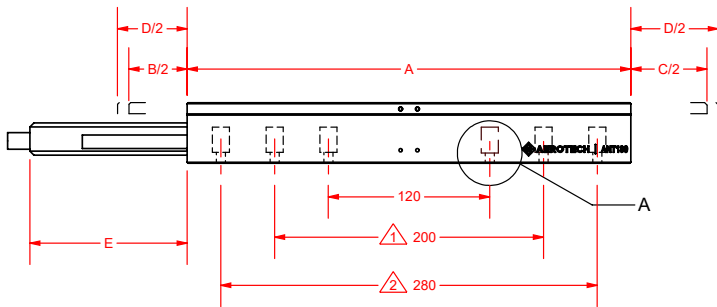
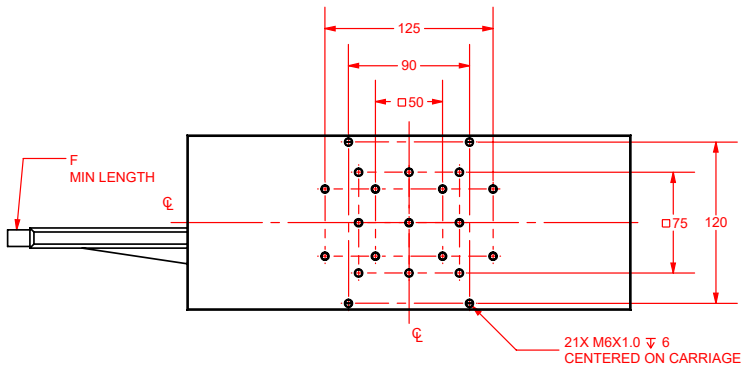

△ ANT130L-110, ANT130L-160 AND ANT130L-210 ONLY

△ ANT130L-210 ONLY

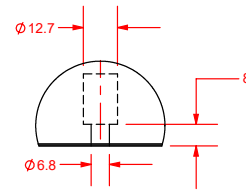
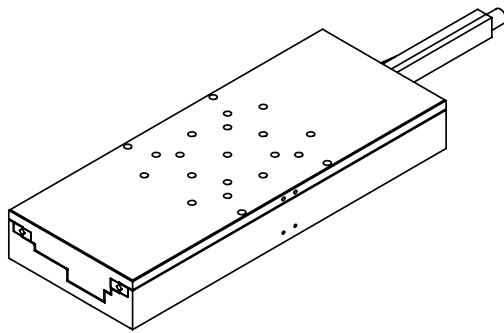

DETAIL A
SCALE 2 : 5
MOUNTING HOLES TYP.

TRAVEL OPTION	A = STAGE LENGTH	B = NOMINAL TRAVEL	C = LIMIT TRAVEL	D = HARDSTOP TRAVEL	E	F
-035	155	35	41	50	27	373
-060	180	60	66	75	42	358
-110	230	110	116	125	67	333
-160	280	160	166	175	92	308
-210	330	210	216	225	117	283

DIMENSIONS: MILLIMETERS

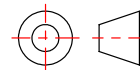

ANT130L DIMENSIONS ANT130L MOUNTING PLATE

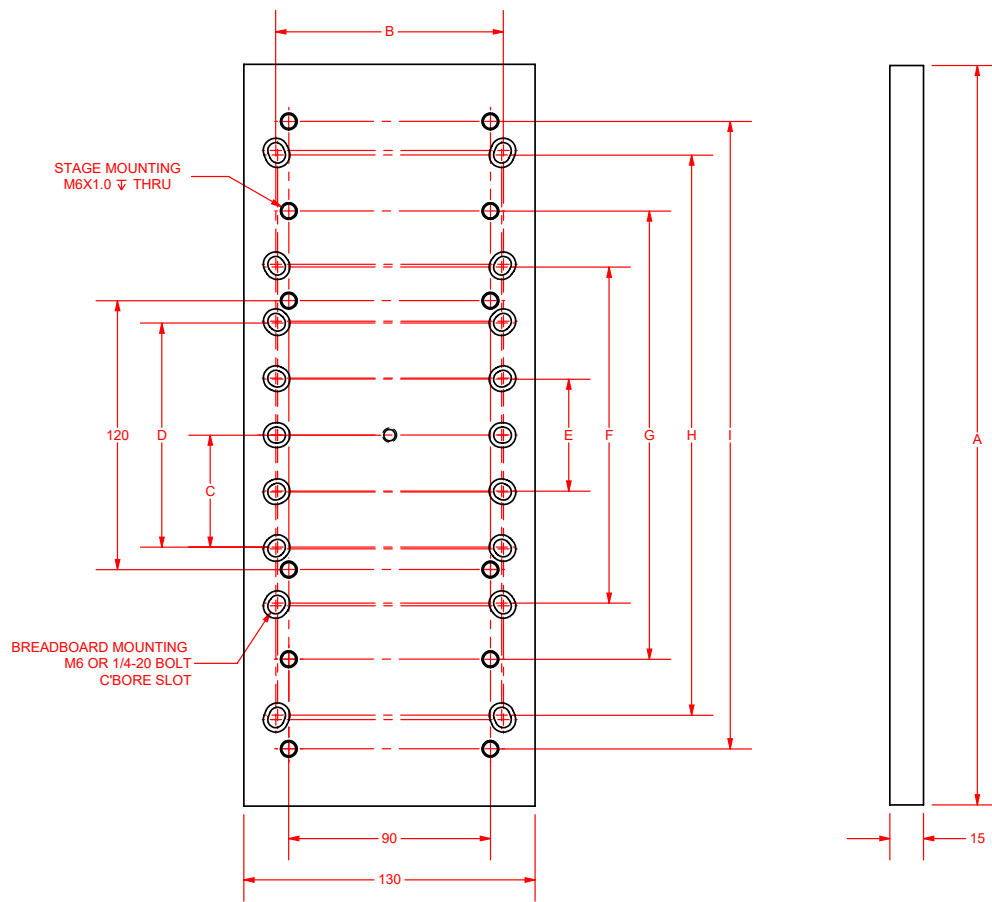

TRAVEL OPTION	LENGTH		MOUNTING						
	A	B	C	D	E	F	G	H	I
-035	155	100 [4.0]	50 [2.0]	100 [4.0]	--	--	--	--	--
-060	180	100 [4.0]	--	--	50 [2.0]	150 [6.0]	--	--	--
-110	230	100 [4.0]	--	--	50 [2.0]	150 [6.0]	200	--	--
-160	280	100 [4.0]	--	--	50 [2.0]	150 [6.0]	200	250 [10.0]	--
-210	330	100 [4.0]	--	--	50 [2.0]	150 [6.0]	200	250 [10.0]	280

DIMENSIONS: MILLIMETERS

