



Single-Axis Z Nanopositioning Stages **ANT130LZ**

Superior Nanometer-Scale Vertical Motion

Our second-generation ANT130LZ stages are specifically engineered to provide nanometer-level motion and positioning performance in the vertical orientation. With a user-adjustable, ultra low-friction pneumatic counterbalance, they are best-in-class in combining accuracy, repeatability, speed and reliability. Their impressive dynamic capabilities and ample load-carrying capacity make ANT130LZ stages an excellent choice when your process demands superior vertical motion.

Key Applications

ANT130LZ stages are ideal for high-precision and high-dynamic vertical positioning applications, including:

- ◆ Photonics assembly & inspection
- ◆ Fiber alignment & optimization
- ◆ Optics manufacturing, testing & inspection
- ◆ Sensor testing & qualification
- ◆ Semiconductor processing & inspection
- ◆ Research & laboratory applications

KEY FEATURES:

- ◆ Enhanced second-generation design
- ◆ Achieves **MINIMUM INCREMENTAL MOTION TO 1 nm - NEW**
- ◆ Delivers **NANOMETER-LEVEL POSITIONING PERFORMANCE** over travel lengths up to 60 mm
- ◆ Offsets payloads up to 10 kg for precise performance in the vertical direction with **USER-ADJUSTABLE, ULTRA LOW-FRICTION COUNTERBALANCE**
- ◆ Features high-precision crossed-roller bearings for **EXCELLENT DYNAMIC PERFORMANCE & AMPLE LOAD CAPACITY**
- ◆ **OPTIMIZES PROCESS THROUGHPUT & MAXIMIZES RELIABILITY** with ironless direct-drive linear motor
- ◆ **ABSOLUTE** and **ULTRA-HIGH RESOLUTION** incremental encoder options are available

ANT130LZ SERIES SPECIFICATIONS

Mechanical Specifications		ANT130LZ-035	ANT130LZ-060
Travel		35 mm	60 mm
Accuracy ⁽¹⁾	Base Performance (-PL1)	±3.0 µm	
	Plus Performance (-PL2)	±300 nm (-E1, -E2, -E3) ±200 nm (-E4)	
Repeatability (Bidirectional) ⁽¹⁾		±75 nm	
Resolution (Minimum Incremental Motion)		2 nm (-E1) 6 nm (-E3) 1 nm (-E4)	
Straightness ⁽¹⁾		±2.0 µm	
Flatness ⁽¹⁾		±2.0 µm	
Pitch		10 arc sec	
Roll		10 arc sec	
Yaw		5 arc sec	
Maximum Speed ⁽²⁾		200 mm/s (-E1, -E3, -E4) 145 mm/s (-E2)	
Maximum Acceleration (No Load)		1 g	
In-Position Stability ⁽³⁾		<2 nm (-E1) <6 nm (-E3) <1 nm (-E4)	
Load Capacity ⁽⁴⁾	Vertical	10 kg	
Moving Mass		1.3 kg	1.5 kg
Stage Mass		5.0 kg	5.7 kg
Material		Anodized Aluminum	
MTBF (Mean Time Between Failure)		30,000 Hours	

Notes:

1. Certified with each stage.
2. Requires the selection of an appropriate amplifier with sufficient voltage and current.
3. In-position stability is reported as 3-sigma value. Requires a 1 Vpp encoder.
4. Payload specifications assume payload is centered on-axis.
5. Specifications are reported for a single axis measured 25 mm above the tabletop. Performance of multi-axis systems depends on the payload and workpoint. Consult factory for multi-axis or non-standard applications.
6. PLUS performance requires the use of an Aerotech controller.
7. To ensure the achievement and repeatability of specifications over an extended period of time, environmental temperature must be controlled to within 0.25°C per 24 hours. Consult factory for more information.
8. Air supply for pneumatic counterbalance must be clean, dry to 0°F dewpoint, and filtered to 0.25 µm or better. Aerotech recommends using nitrogen at 99.9% purity. Supply pressure is determined by the amount of payload carried by the stage.

Electrical Specifications	ANT130LZ-035	ANT130LZ-060
Drive System	Brushless Linear Servomotor	
Feedback	Noncontact Linear Encoder 1 Vpp with 20 µm signal period (-E1) Digital RS422 (-E2) BiSS-C absolute + incremental 1 Vpp linear dual-track encoder (-E3) 1 Vpp with 4 µm signal period (-E4)	
Maximum Bus Voltage	-CN1: 80 VDC -CN2: 160 VDC	
Limit Switches	5 V, Normally Closed	
Home Switch	Near Center	

ANT130LZ SERIES ORDERING INFORMATION

Travel (Required)

-035	35 mm travel
-060	60 mm travel

Feedback (Required)

-E1	Incremental linear encoder, 1 Vpp amplified sine output
-E2	Incremental linear encoder, digital RS422 output, 5 nm electrical resolution
-E3	Absolute + Incremental 1 Vpp linear dual-track encoder
-E4	Incremental linear encoder, 1 Vpp amplified sine output, high-performance

Connectors (Required)

-CN1	Single 25-pin D connector, 25DU
-CN2	Two connectors, 4-pin HPD and 25-pin D, 4DU-25DU

Note: The -CN1 option is limited to a maximum bus voltage of 80 V. The -CN2 option is required for higher bus voltages.

Performance Grade (Required)

-PL1	Base performance
-PL2	High-accuracy performance, PLUS

Integration (Required)

Aerotech offers both standard and custom integration services to help you get your system fully operational as quickly as possible. The following standard integration options are available for this system. Please consult Aerotech if you are unsure what level of integration is required, or if you desire custom integration support with your system.

-TAS Integration - Test as system

Testing, integration, and documentation of a group of components as a complete system that will be used together (ex: drive, controller, and stage). This includes parameter file generation, system tuning, and documentation of the system configuration.

-TAC Integration - Test as components

Testing and integration of individual items as discrete components that ship together. This is typically used for spare parts, replacement parts, or items that will not be used together. These components may or may not be part of a larger system.

ANT130LZ SERIES SPECIFICATIONS

ANT130LZ SERIES PERFORMANCE

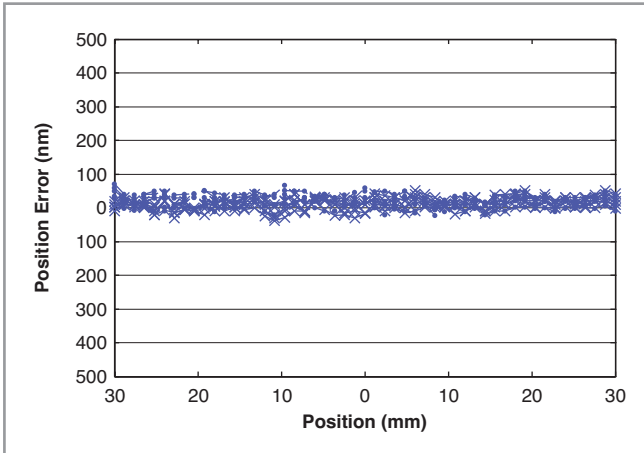

ANT130LZ-060-E1-PL2 accuracy and repeatability, five runs, bi-directional over an extended period of time shows the high level of system accuracy and repeatability.

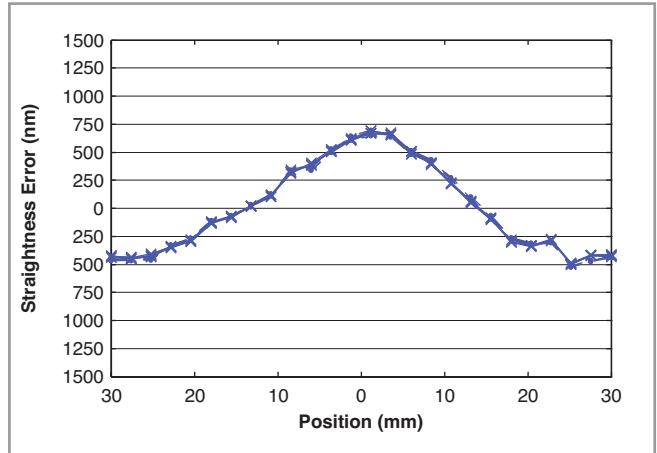

ANT130LZ-060-E1-PL2 straightness error, five runs, bi-directional. Exceptional and highly repeatable performance is assured with minimal straightness error.

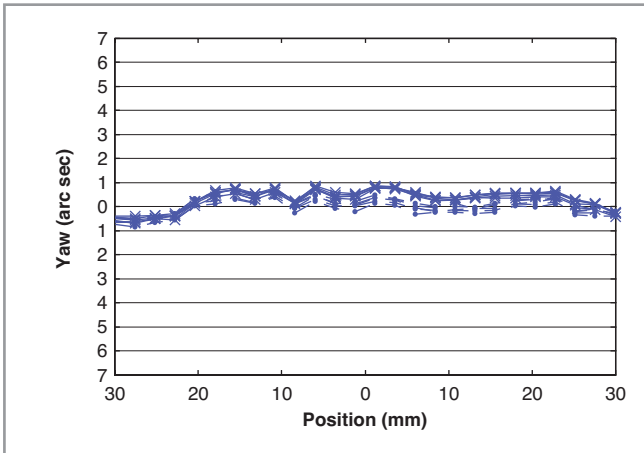

ANT130LZ-060-E1-PL2 yaw, five runs, bi-directional. Highly repeatable, minimal yaw error enhances system positioning accuracy.

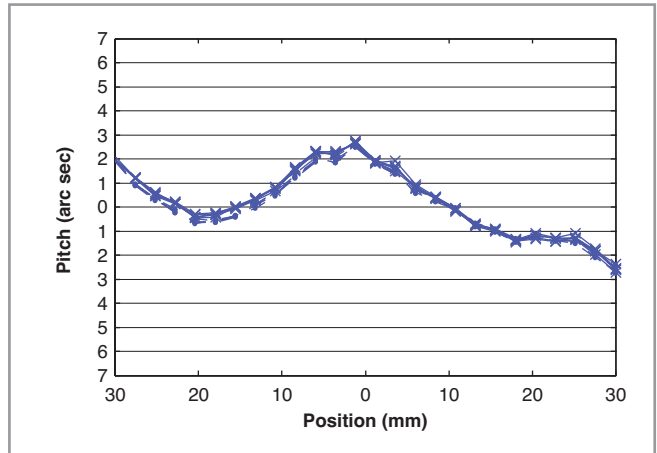

ANT130LZ-060-E1-PL2 pitch, five runs, bi-directional. Excellent repeatability and accuracy contribute to improved processing.

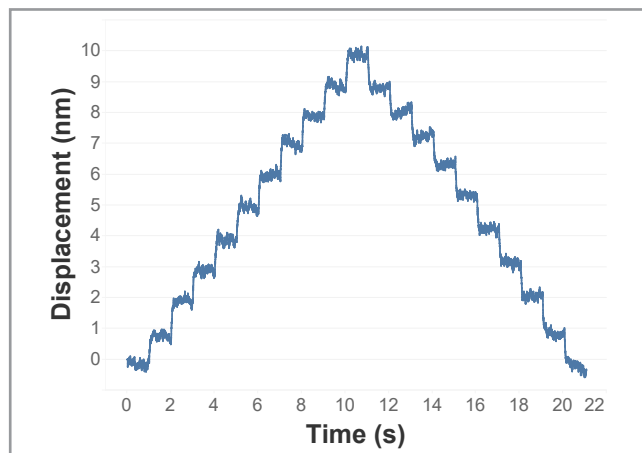

ANT130LZ-060-E4-PL2 step plot showing 1 nm minimum incremental motion. Best-in-class resolution and exceptional in-position stability for large travel stages.

ANT130LZ DIMENSIONS

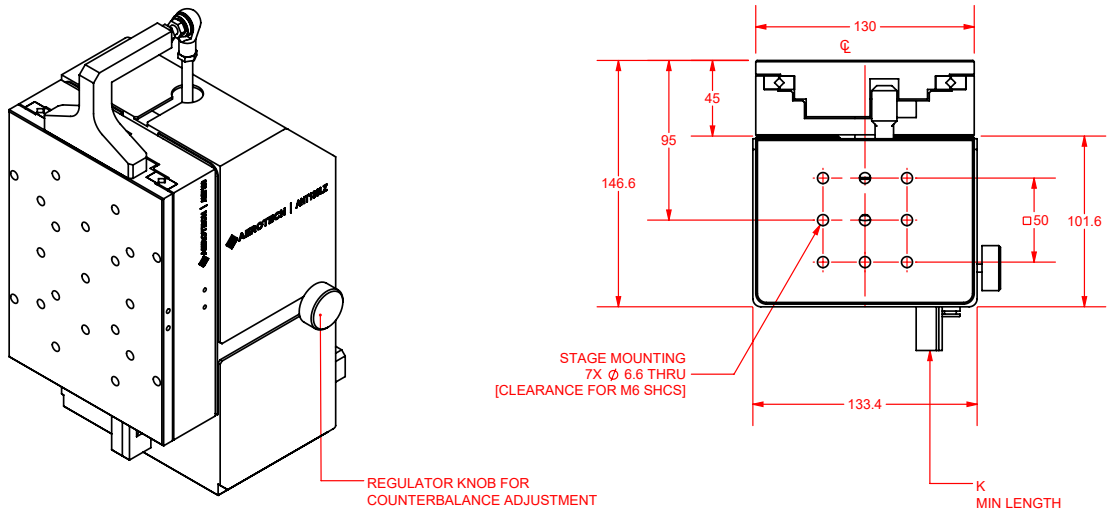
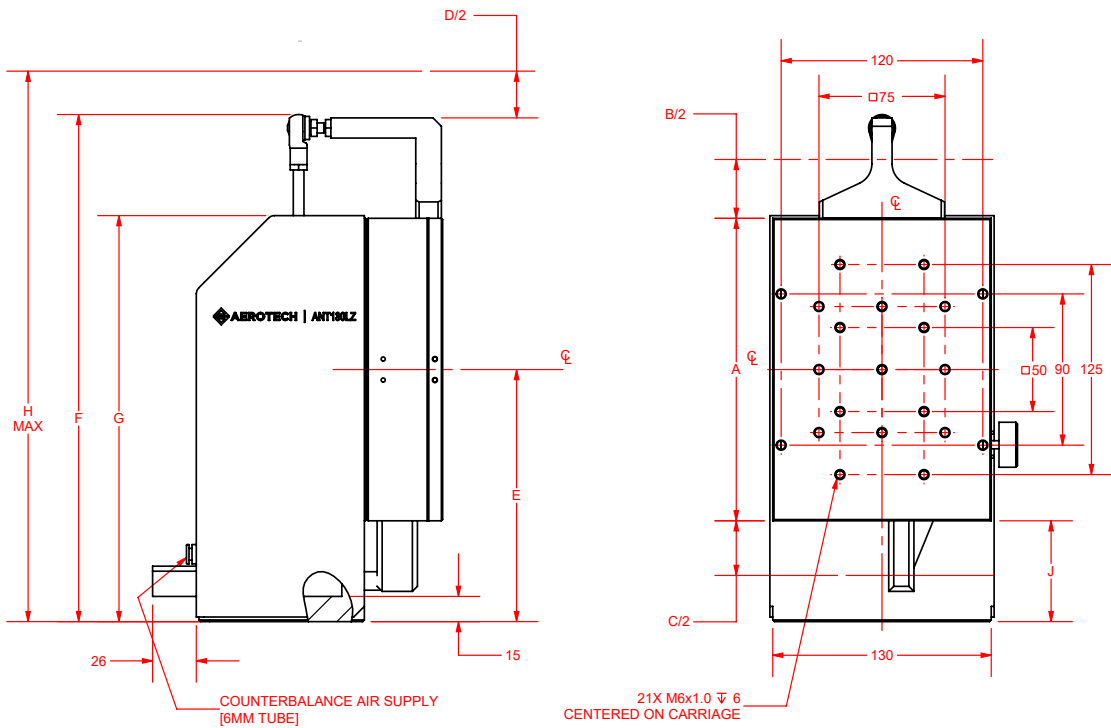

TRAVEL OPTION	A = STAGE LENGTH	B = NOMINAL TRAVEL	C = LIMIT TRAVEL	D = HARDSTOP TRAVEL	E	F	G	H	J	K
-035	155	35	41	50	125	251.8	204.1	276.8	47.5	734
-060	180	60	66	75	150	301.8	241.6	339.3	60	724

DIMENSIONS: MILLIMETERS

